

CLOSETMAID[®] PROSM



VENTILATED
Wire Shelving





GREAT WIRE SOLUTIONS FOR EVERY ROOM

Wherever homeowners need storage and organization in the home, ClosetMaid® has the answer.

More economical than wood, ClosetMaid offers five types of wire shelving to match functions and costs. Add the strength of spot-welded, extruded steel, wrapped in durable, vinyl color coating, and you no longer have to worry about budget, structural integrity, corrosion, painting plank-and-pole, or waiting to install until the floors go in.

With ClosetMaid, your homeowners get the perfect storage in every closet and every room in the home, and you spend less time dealing with it.

LEFT: SHELFTRACK WIRE SYSTEM WITH LINEN SHELVING IN WHITE

TWO GREAT WIRE SYSTEMS—PICK YOURS

ClosetMaid offers two ventilated wire shelving systems to meet your project's budget: our original, Fixed Mount System and the industry's best adjustable system, ShelfTrack®.

Both offer a variety of design and accessory options. And both feature the same fully-encapsulated, vinyl-coated material that ensures structural integrity, and prevents rust, chipping and discoloration seen in lesser, epoxy-coated alternatives.

Available Finishes

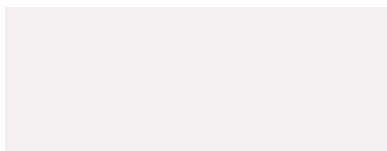

WHITE



SATIN CHROME

**Some variants may be present.*

wire systems





TOP: FIXED MOUNT WIRE SYSTEM WITH SHELF & ROD SHELVING IN WHITE

BOTTOM: SHELFTRACK WIRE SYSTEM WITH LINEN SHELVING IN WHITE

Fixed Mount System

We invented ventilated, wire storage systems, and ours remain the most economical on the market. True to its name, the system is fixed to the wall at set heights and is ideal for all storage areas.

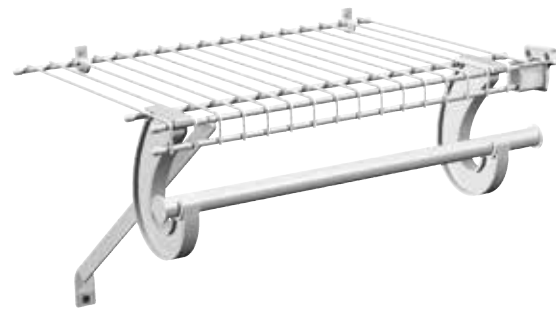

ShelfTrack System

The adjustable alternative is ShelfTrack. Easy to install, this flexible design allows homeowners to alter shelf heights and positions as needs change, and can also be configured to meet ADA requirements. Strong and durable, the wall-mount hardware includes tracks, standards, and brackets.

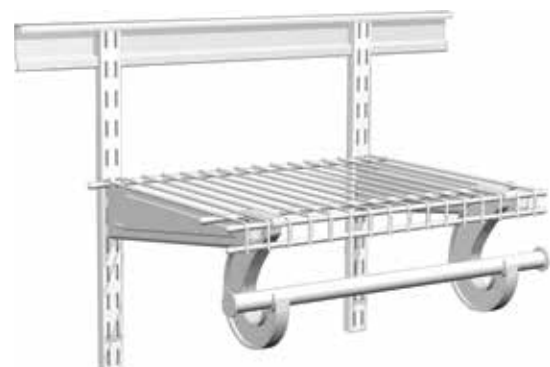

Shelving Options

to organize everything

Once you've chosen a fixed or adjustable storage system, it's all about the kind of shelf you need. Obviously, shelves for heavy tools are different than those for folded linens or for small pantry items prone to tip over.

ClosetMaid has them all.

Linen (All-Purpose)

Shelf & Rod

Close Mesh

TotalSlide

Heavy Duty

Then, you have more options for the perfect job, like lengths, depths, and finishes.

Those options solve 99% of homeowners' needs, but ClosetMaid's ventilated wire systems can also be specified for a variety of applications based on suitability and strength requirements.





LINEN (ALL-PURPOSE)

This shelf is ideal for large or folded items like linens, purses and sweaters. Upgrade with continuous sliding hang rod attachment available for 12 in. or 16 in. shelving.

Available Depths: 6 in., 9 in., 12 in., 16 in., 20 in.

Finishes: White, Satin Chrome

Perfect Room(s): Any bedroom, hall or linen closet, laundry, and utility rooms

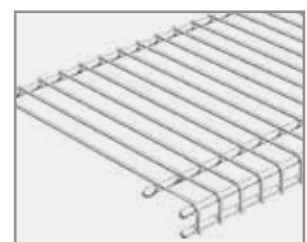



SHELF & ROD

Fast, simple closet storage with hanging rod integrated in the shelf with stops every 12 in.

Available Depths:

10 in., 12 in., 16 in.

Finishes:

White, Satin Chrome

Perfect Room(s):

Hall, linen, bedroom closets, laundry

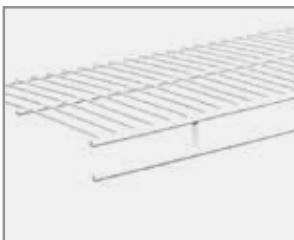



CLOSE MESH

Our narrower, 5/8 in. wire spacing vs. the 1 in. standard prevents small items from tipping, spilling or breaking.

Available Depths:

9 in., 12 in., 16 in., 20 in.

Finishes:

White, Satin Chrome

Perfect Room(s):

Pantry, bathroom,
utility room

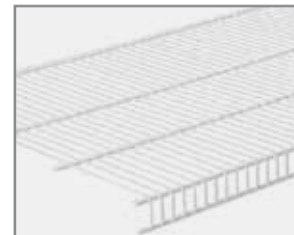



TOTALSLIDE

With a continuous and integrated sliding rod, clothes slide without interruption. And the slim profile rod offers reliable strength.

Available Depths:

12 in., 16 in.

Finishes:

White, Satin Chrome

Perfect Room(s):

Bedroom, hall closets, laundry





HEAVY DUTY

Ideal for storing heavy, large items. With ShelfTrack hardware, our Heavy Duty wire shelving supports 100 lbs. per linear ft.

Available Depths:

12in and 16in.

Finishes:

White, Satin Chrome, Glossy Black

Perfect Room(s):

Basement, garage, utility closets

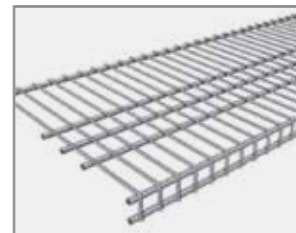

Personalize

Every room is unique. Now, it's easy to customize the whole home.





SHELFTRACK ACCESSORIES

Upgrade a ShelfTrack system further with a variety of options like shoe racks, belt racks, drawer kits, baskets, bookshelves, and more.

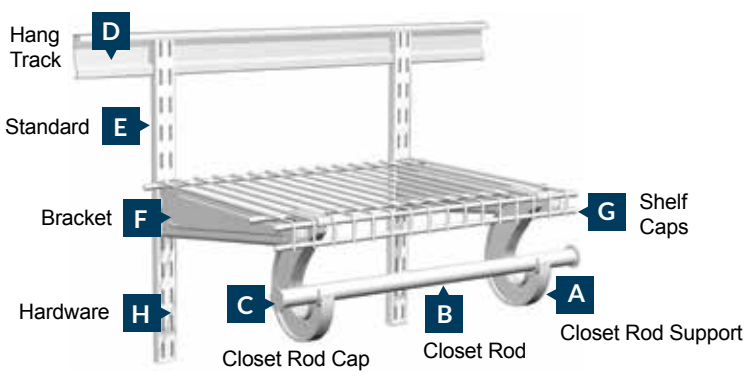

1. SHELFTRACK EXPANDABLE SHOE RACK

Adjustable width and depth to fit any size shoe.
The shelves expand from 24 in. to 42 in.

2. SHELFTRACK LARGE BASKET

3. SHELFTRACK HOOKS

4. SHELFTRACK SHOE BRACKETS

Make a shoe shelf by inverting shelf, lip facing up.



SHELFTRACK BOOK SHELF KIT



SHELFTRACK 4-DRAWER KIT



Available Finishes

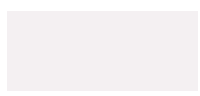

WHITE



SATIN CHROME

WIRE SYSTEMS

SHELVING

BENEFITS

Fixed Mount System

- Fixed-mounted to the wall at set heights
- Ideal for all storage areas
- Most economical system on the market

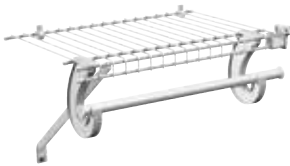

FINISH

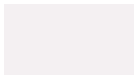

WHITE

ShelfTrack System

- Adjustable vertically and horizontally
- Ideal for all storage areas
- Excellent solution for senior living, children's rooms, pantries, offices, and garages
- Meets ADA requirements



FINISH

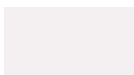

WHITE

SATIN CHROME

Linen (All-Purpose)

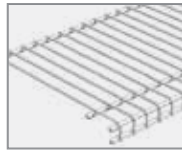

- Allows for visibility of items
- Ideal for folded items such as linens
- Perfect room(s): closets, laundry room or utility room

Close Mesh



- Allows for visibility of items
- 5/8 in. wire spacing instead of 1 in. standard
- Prevents small items from tipping over
- Perfect room(s): pantry, bathrooms, linen closet or utility room

Shelf & Rod



- Allows for visibility of items
- Standard closet shelf with integrated hanging rod
- Hanger glide interruption every 12 in.
- Perfect room(s): closets and laundry rooms

Heavy Duty



- Allows for visibility of items
- Supports 100 lbs. per linear ft. using our ShelfTrack hardware
- Ideal for storing heavy, large items
- Perfect room(s): garage, basement, or utility room

TotalSlide



- Continuous sliding rod integrated with shelf
- Utilizes heavier gauge steel rod at critical support points
- Perfect room(s): closets, laundry room or utility room

AVAILABLE DEPTHS

FINISH

6 in., 9 in. and 20 in.

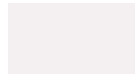

WHITE

12 in. and 16 in.

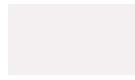

WHITE



SATIN CHROME

9 in. and 20 in.

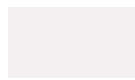

WHITE

12 in. and 16 in.

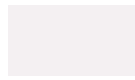

WHITE



SATIN CHROME

12 in. and 16 in.

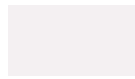

WHITE

10 in. and 16 in.
with 10 in. hang

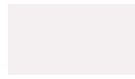

WHITE



SATIN CHROME

12 in. and 16 in.

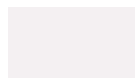

WHITE



SATIN CHROME



GLOSSY
BLACK

12 in. and 16 in.

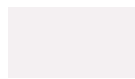

WHITE



SATIN CHROME

Ventilated wire

at a glance

Make every project a

SUCCESS

WE SUPPORT OUR PROS

ClosetMaid wire shelving is backed by our outstanding professional support services to give you confidence in the product and make projects more profitable. No matter how big or small the project, we're here to help you succeed in building high-quality, best-in-design, personalized organization.

Contact Us

We're here to help.

For design services and assistance, email your request to: design@ames.com



RIGHT: FIXED MOUNT WIRE SYSTEM WITH TOTALSLIDE IN WHITE



IMPROVING EVERY HOME, INCLUDING EARTH

ClosetMaid's ventilated wire shelving is certified by SCS Global Services, a leading third-party resource for environmental labels and claims. Our ventilated wire products are made from 91% recycled content including 86% post-consumer and 5% pre-consumer recycled steel.

Products that carry the SCS Recycled Content Certification can help meet LEED criteria specified by the U.S. Green Building Council (USGBC).

Recently, ClosetMaid wire shelving gained additional distinction by earning SCS' Indoor Advantage Gold Certification which meets California Specification 01350 indoor air quality standards for school classrooms, private offices and single family residences.

ClosetMaid's vinyl-coating process on wire shelving ensures durable encapsulation of steel wire and welds to resist chips, rust and UV discoloration.

ClosetMaid wire shelving is proudly Made in the USA.



INDOOR ADVANTAGE GOLD
FURNITURE



MINIMUM 91% RECYCLED CONTENT
87% POST-CONSUMER
4% PRE-CONSUMER



Made in the USA



Follow Us to Get Inspired:
@closetmaid

Toll Free:
1.800.221.0641

Email:
pro@ames.com

Pros:
closetmaidpro.com

Homeowners:
customclosetmaid.com



13485 Veterans Way, Suite 200, Orlando, Florida 32827

Toll - Free # 1-800-221-0641

www.closetmaidpro.com

© 2022 ClosetMaid LLC

