



SECURING
CONFIDENCE.
OPENING
POSSIBILITIES.



PRODUCT DIGEST

Customer Support

Customer Support

Our Customer Support team is available to answer questions or provide any assistance you may need.

717.656.4281, help@pdqlocks.com.

Monday through Friday – 8am to 5pm EST.

Placing Orders

To place orders, email:

orders@pdqlocks.com

Product and Technical Support

PDQ Mechanical: 833.273.7832, support@pdqlocks.com

Quotation and Product Cross Reference

quotes@pdqlocks.com, 717.656.4281

Value Engineering Services (Complimentary)

quotes@pdqlocks.com, 717.656.4281

Specification Writing Services (Complimentary)

quotes@pdqlocks.com, 717.656.4281

World Headquarters Administrative Office U.S. Manufacturing Center

PDQ Manufacturing
2230 Embassy Drive
Lancaster, PA 17603 USA

Remittances

PDQ Manufacturing
P.O. Box 6426
Lancaster, PA 17607 USA

Regional Distribution Centers

Lancaster, PA, Norcross, GA, Auburn, WA

International Sales and Distribution Centers

Abu Dhabi, United Arab Emirates

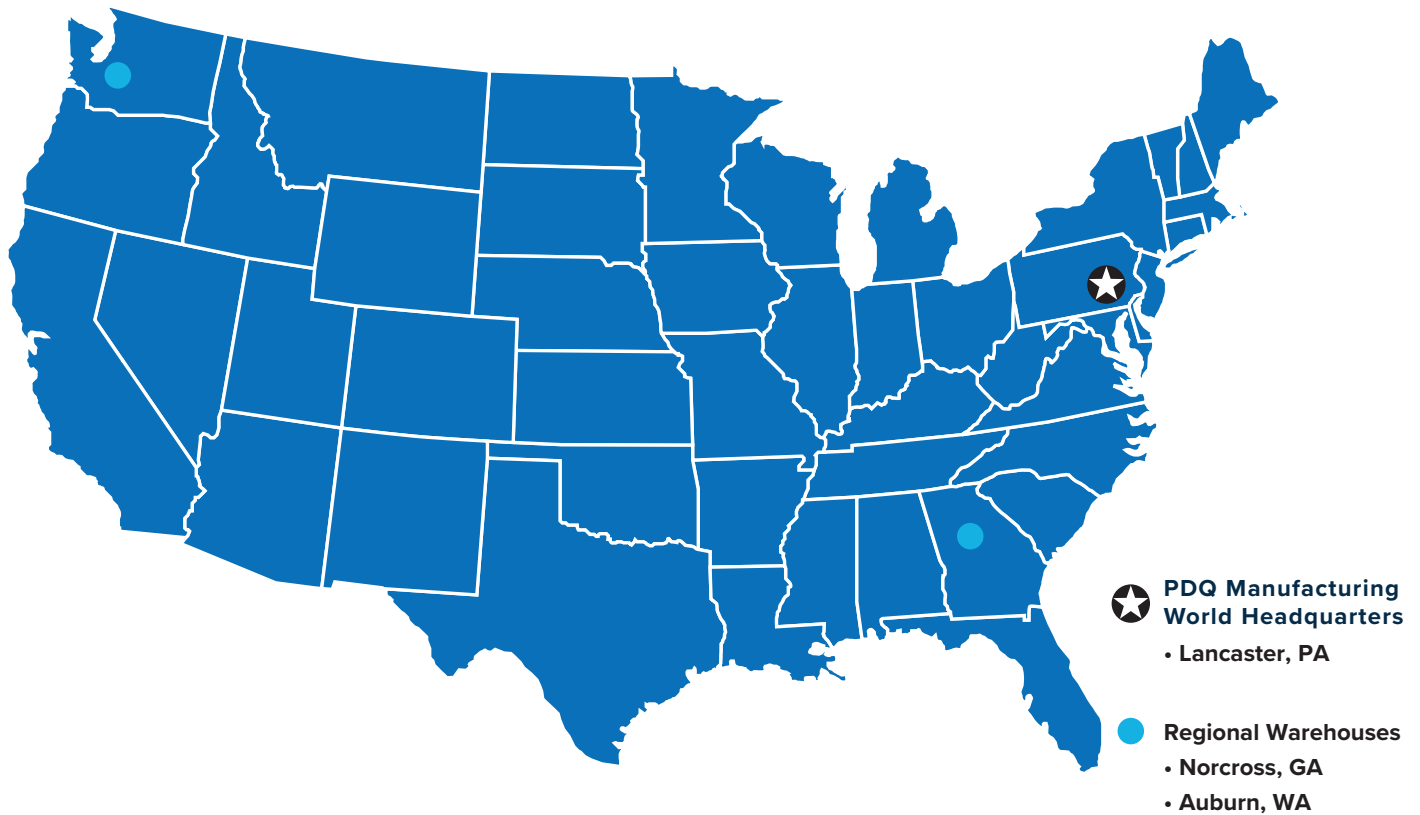

 **PDQ Manufacturing
World Headquarters**
• Lancaster, PA

 **Regional Warehouses**
• Norcross, GA
• Auburn, WA

Table of Contents

About PDQ	4
Mortise Locks	5
Grade 1 Mortise Locks	6
Electrified Mortise	8
Trim and Levers	10
Cylindrical Locks Grade 1	11
Grade 1 Cylindrical Locks	11
School Security Solutions	15
Ball Knobs	16
Cylindrical Locks Grade 2	17
Grade 2 Cylindrical Locks	18
Interconnected Locks	21
Ball Knobs	22
Tubular Locks	23
Tenant Tubular Locks	23
Electrified Locks	24
Electrified Cylindrical Locks	24
Deadbolts	25
Deadbolts	26
Cylinders, Keying Systems and Keys	30
Standard, High Security, UL437 Cylinders, Cores, Keying Systems, Keys and Keyways	31
Padlocks, European Profile IC Cores	32
Interchangeable Core Padlocks	32
European Profile Interchangeable Cores	32
Exit Devices – High Performance	33
Heavy-Duty Wide Stile	35
Heavy-Duty Narrow Stile	35
Trim and Levers	40
Mullions	41
Electrified Exit Devices – Options/Accessories	42
Electrified Trim	42
Quiet Latch Retraction	42
Delayed Egress	43
Electrified Options/Accessories	45
Exit Devices – Commercial Grade	47
Wide Stile	48
Trim and Levers	49

Surface Mounted Door Closers	50
Institutional – High Traffic, High Abuse	51
Commercial – Moderate Traffic	52
Light Commercial – Low Traffic	54
Spring Cushion Stop	55
Sliding Barn Door Hardware	56
Sliding Barn Door Hardware	56
Hinges	57
Commercial Hinges	57
Electrified Accessories	58
Electrified Hinges	58
Key Switches/Push Buttons	58
Electric Strikes	59
Power Supplies	60
Flat Goods	61
Privacy Latch Guards	61
Flush and Surface Bolts	61
Coordinators	61
Push Plates	61
Pulls and Pull Plates	61
Push and Push-Pull Bars	61
Fasteners	61
Door Protection Plates	61
General Hardware	62
Wall Stops and Holders	62
Floor Stops and Holders	62
Kick Down Door Stops	62
Hinge Stops	62
Roller Stops	62
Roller Latches, Catches and Protectors	62
Hooks, Silencers, Door Viewers, Strikes	62
PDQ/SKILCRAFT AbilityOne Program	63
Warranty	64
Levers	65
Decorative Finish Collection	66
Architectural Finishes by Product Series	67

Headquarters and Manufacturing



World Class Manufacturing and Design

- 80,000 Square Foot Facility
- Domestic Engineering, Design, and Product Development
- On-site Tool and Die Shop
- Intertek Certified Testing Facility (Continuous Process)
- Lean Manufacturing
- Six Sigma Process
- Value Stream Mapping
- Replenishment Flow Racks/Linear Assembly Line and Cells



Designed to Over-Perform

Tested to 11 million cycles and still counting! That's how PDQ backs up its claim to manufacture some of the toughest hardware in the market. Our mortise locks are built to withstand the rigors of daily use without fail, keeping people and their assets safe while delivering consistent reliable performance. Easy to install, and simple to repair and maintain. That means fewer callbacks for you and total safety and security for your customers.

MR Mechanical



Applications

Healthcare, K-12, higher education, offices, commercial buildings and government facilities.

MR199A Electrified

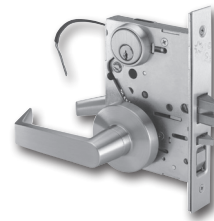

Applications

Computer rooms, storage areas, child care facilities, restrooms, nursing staff lounges and stairwell towers.

MR Visual Indicators



Applications

Classroom security, student housing and traditional OCCUPIED/ VACANT and LOCKED/UNLOCKED applications.

TJ Tubular Lock

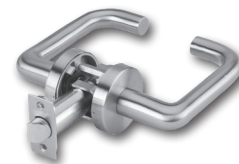

Applications

Interior doors in high-end residential, multi-family and commercial spaces. Trim matches MR mortise achieving a coordinated look throughout the property.

GRADE 1



Top Performer in the Industry. Lifetime Warranty

- Versatile – Single cam for all locking functions
- Available in multiple escutcheon widths



ADA COMPLIANT



Specifications

FOR DOORS:	• 1-3/4" standard, 2" - 3" special order from factory
BACKSET:	• 2-3/4"
CASE:	• 12-gauge cold rolled steel mechanism • Dichromated for corrosion resistance • Features weakened spindle design to prevent case damage
ARMOR FRONT:	• Beveled 1/8" on 2" • 625 (US26) & 630 (US32D) use stainless steel as base material, all other finishes use stainless steel or brass as base material
STRIKE:	• Non-handed Curved Lip Strike • 625 (US26) & 630 (US32D) use stainless steel as base material, all other finishes use stainless steel or brass as base material
LEVERS:	• F Series Sectional/Escutcheon: Philadelphia, Boston, Miami • J Standard and J Wide Trim: Philadelphia, Boston, Miami, Chicago, Dallas, Houston, Los Angeles, Memphis, Orlando, Ball Knob
LATCHBOLT:	• 3/4" Throw • Investment Cast Stainless Steel • Anti-friction
DEADBOLT:	• 1" Throw • Investment Cast Stainless Steel
HAND:	• Most functions field reversible. Specify handing for Strikes, consult factory for details
TRIM:	• F trim - forged brass levers and escutcheons • Round and square rose available • J Standard and J Wide Trim - stainless steel escutcheon and levers, PHL, MEM, MIA and BSN are solid levers LAX, ORL, DAL and CHI are tube levers
KEYS:	• Two (2) per Lock
KEYWAYS:	• SCC standard (Schlage C Compatible) • Also available in keyways of other manufacturers
INTERCHANGEABLE CORE:	• 6 or 7-pin • Compatible with Best, Falcon & Arrow • Large Format IC Cores compatible with Schlage.
CYLINDER:	• 6 or 7-pin Brass Mortise Cylinder • Standard High Security and UL437 Cylinders Available
KEYING:	• Options: MK, CMK or GMK • Zero Bitted (KO), Keyed Different (KD) or Keyed Alike (KA) Can be keyed into existing master key systems
FINISHES:	• F Series Trim: 626 (US26D) • J Standard and J Wide Trim: 605 (US3), 606 (US4), 612 (US10), 613E, 622 (US19), 629 (US32), 630 (US32D) • Antimicrobial Coating available on 626 (US26D) & 630 (US32D) for F, J, and J Wide Series.
PERFORMANCE:	• Tested to over 11 million cycles, 11X ANSI/BHMA standard
CERTIFICATIONS, LISTINGS, COMPLIANCES:	• UL listed for 3 hrs, for single doors up to 40" x 80" • Certified to ANSI/BHMA 156.13 Operational Grade 1 and Security Grade 1 • Approved for Florida HVHZ (High Velocity Hurricane Zone). PDQ Product Approval: FL 21376. Design load rating: ± 70.0 PSF for single door (3' x 7') • Complies with ADA (Americans with Disabilities Act) and ICC/ANSI 117.1 for Accessible and Usable Buildings • J Wide Escutcheon Trim complies with Unified Facilities Guide Specification 08 71 00 (August 2008)
WARRANTY:	• Lifetime Limited Warranty
COUNTRY OF ORIGIN:	• Assembled in the U.S.A. with U.S. and foreign material. Meets requirements of the Buy American Act as a COTS product manufactured in the United States.

Note: Heavy Duty Spindle for High Abuse situations is available for F trim.

‡ Available with antimicrobial coating, technology that is known to inhibit the growth of microbes.

Non-Keyed Companion to MR Mortise Lock

- Shares common high-end trim and levers with MR Mortise
- TJ/MR combination delivers a uniform look throughout apartment

Features

- Contemporary decorative trim perfect for high end residential and office work
- Designed to compliment MR Series Mortise locks sharing the same sectional rose diameter and levers
- Investment cast stainless steel trim
- Range of lever styles available
- Available in round rose or square rose
- Uses a slender 1-3/8" diameter rose providing a clean contemporary look

Typical Applications

- High-End Residential
- Multi-family
- Offices

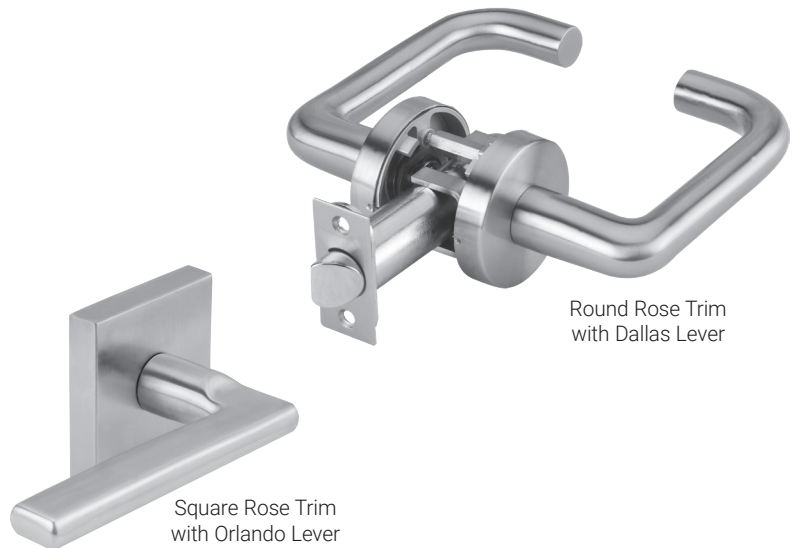

Specifications



FOR DOORS:	• For doors 1-3/8" (35mm) to 1-3/4" (44mm) thick standard
BACKSET:	• 2-3/4" (70mm) default. Optional: 2-3/8" (60mm);
STRIKE:	• "Full Lip" strike default. "T" strike and ANSI/ASA strike optional
ROSE DIMENSIONS:	• Round Rose: 2-3/8" DIA • Square Rose: 2-9/16"
DOOR PREP:	• ANSI Standard 115.2, Type 161 for 2-3/4" Backset • Type 160 optional
LATCH BOLTS:	• 2-3/4" Backset has 1-1/8" faceplate. 2-3/8" Backset has a 1" faceplate filler
HAND:	• Non-handed, except Memphis and Orlando
FINISHES:	• 605 (US3) Bright Brass, 606 (US4) Satin Brass, 612 (US10) Satin Bronze, 613E Dark Oxidized Satin Bronze, 622 (US19) Flat Black, 629 (US32) Bright Stainless Steel, 630 (US32D) Satin Stainless Steel
TRIM:	• Stainless Steel Levers and Roses
LEVER DESIGNS:	• Philadelphia, Boston, Miami, Chicago, Houston, Memphis, Orlando, Los Angeles, Dallas and Ball Knob.
CERTIFICATIONS, LISTINGS, COMPLIANCES:	• Complies with ADA (Americans with Disabilities Act) and ICC/ANSI 117.1 for Accessible and Usable Buildings
WARRANTY:	• Five (5) year limited warranty (except ball knob)

Flexible Design Accommodates Multiple Voltages

- Universal input voltage: 12/24V both AC and DC, out-of-the box
- FAIL SECURE/FAIL SAFE is field selectable
- Get the job done right on the first visit
- MR199A Electrified Storeroom
- MR200 Electrified Institutional

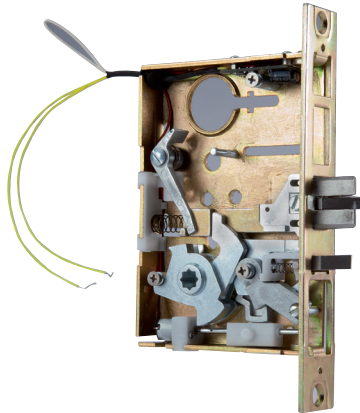

Innovative motor drive controls FAIL SECURE or FAIL SAFE locking mode.

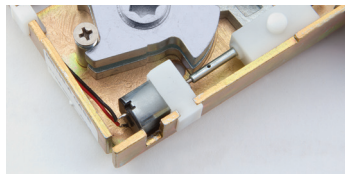

Typical Applications

- Child Care Facilities
- Computer Rooms
- Nursing Staff Lounges
- Rest Rooms
- Stairwell Towers
- Storage Areas

Features

- Motorized locking/unlocking.
- FAIL SECURE (Factory Default) – Outside trim is UNLOCKED when power is ON, and LOCKED when power is OFF. Lockset will lock in the event of a power failure.
- FAIL SAFE – Outside trim is LOCKED when power is ON, and UNLOCKED when power is OFF. Lockset will unlock in the event of a power failure.
- Field changeable from FAIL Secure to FAIL SAFE.
- Built around PDQ's world class MR series mortise lock chassis platform.
- Meets requirements of the Buy American Act.
- SMARTSENSE™ control board automatically accepts AC or DC input voltage.
- Request to exit option.
- Latch bolt monitor option.
- Field reversible handing - consult factory.

Specifications



PERFORMANCE:	<ul style="list-style-type: none"> • Motor drive factory tested to over 1.4 million cycles (1.4 times the ANSI/BHMA grade 1 std).
RECOMMENDED POWER SUPPLY:	<ul style="list-style-type: none"> • PDQ Model # 81440. <ul style="list-style-type: none"> – Input: 120VAC, .9A, 50/60Hz 240VAC, .6A, 50/60Hz – Output: 24VDC, 2A, filtered and regulated. • Rated for simultaneous operation of 2ea mortise lock assemblies. • Power Supply Requirements: <ul style="list-style-type: none"> – AC/DC Output Voltage – 1A min (filtered and regulated). • 12-24VDC @ < 1A initial surge (1 sec), 5mA standby after 30 sec. – AC Output Voltage. • 12-24VAC (60Hz) @ < 1A initial surge (1 sec), 15mA standby after 30 sec
ELECTRICAL SPECIFICATIONS:	<ul style="list-style-type: none"> • Input voltage: 12-24VDC or 12-24VAC. • Max In-rush current: 1.0A. • Standby current: <ul style="list-style-type: none"> – 12VAC: 12mA. – 24VAC: 10mA. – 12VDC: 3mA. – 24VDC: 5mA. Note: Operating voltage at ± 10% of rated voltage.
CERTIFICATIONS, LISTINGS, COMPLIANCES:	<ul style="list-style-type: none"> • ANSI/UL10C and CAN/ULC-5104 Listed for "Fire Exit Hardware" up to 3 hours for 4'0" x 8'0" maximum single, 8'0" x 8'0" maximum pairs. • Assembled in the U.S.A. with U.S. and foreign material. Meets requirements of the Buy American Act as a COTS product manufactured in the United States.
WARRANTY:	<ul style="list-style-type: none"> • 2-Years

Built to Last

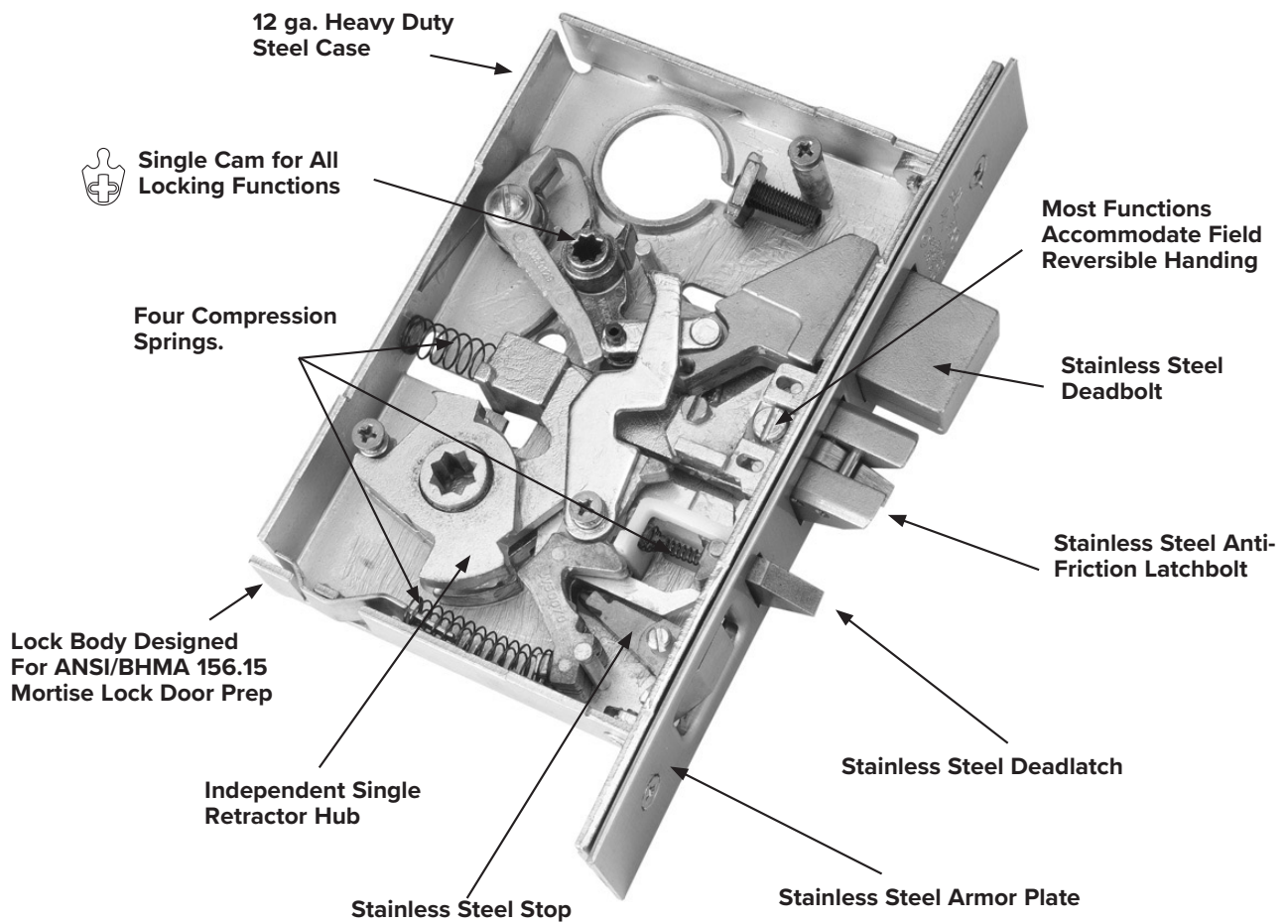



Escutcheon

F Series Trim



F Trim
2-1/16" W x 7-5/8" H
626 (US26D) Finish Only
(Brass Escutcheon)

J Series Trim



J Trim
1-3/4" W x 7-5/8" H

J Wide Trim
2-9/16" W x 8" H

7 Finishes (605, 606, 612, 613, 622, 629, 630)
Specify 630 in Lieu of 619
(Stainless Steel Escutcheon)

Sectional

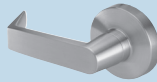

SF Trim
Round Rose
(Brass)

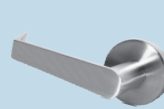

SJ Trim
Round Rose
(Stainless Steel)



SR Trim
Square Rose
(Stainless Steel)

Levers



Philadelphia



Boston



Miami

All Levers Brass



Philadelphia



Boston



Miami



Chicago



Dallas



Los Angeles



Memphis



Orlando



Houston



Ball Knob
(Non-ADA)

All Levers Stainless Steel

Finishes



605 (US3)
Bright Brass
*F-Trim Only



606 (US4)
Satin Brass



612 (US10)
Satin Bronze



613E
Oil Rubbed
Bronze



622 (US19)
Flat Black



626* (US26D)
Satin
Chromium



629 (US32)
Bright
Stainless Steel



630 (US32D)
Satin Stainless
Steel

More Duty Than You Can Handle

Most manufacturers' approach to lock design ends with simply meeting BHMA/ANSI standards but not PDQ. Our philosophy is to step out of the box and develop innovative designs that take our locks to the next level. We don't just meet the standard, we crush it. Our design doctrine delivers the confidence that locks are built to last, whether the application calls for resistance to high abuse or to millions of cycles of operation without any degradation in performance

XGT/GT Mechanical

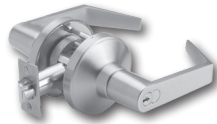

Applications

High traffic doors, areas subject to severe abuse, K-12, higher education, Healthcare, public buildings and retro-fit applications.

XGT/GT199A Electrified



Applications

Stairwell towers, tenant spaces, pharmacies, computer rooms and high security areas.

XGT/GT135LED School Security Solution



Applications

In K-12 and higher education, indicators are part of the overall security plan. The GT135LED Classroom Intruder lock is designed to allow a staff member to use the inside cylinder to lock the outside of the door. The Intruder function eliminates the need to open the door to check for a locked lever. Simply press the button on the lock and if the red LED lights up the outside lever in locked and secure. If the LED does not light up, the outside lever is unlocked.

SX Ball Knob



Applications

High traffic areas, Healthcare and commercial buildings.

XGT/GT SERIES

Extraordinary Design. Amazing Performance.



XGT Exclusive

Cast stainless steel spindle yields over 3,000 in-lbs lever torque resistance. No clutching or free wheeling necessary!



Anti-rotation through bolts at 6 and 12 o'clock (A)

Cast alloy chassis



Vandal resistant heavy duty cast levers with Triple thick leaf spring helps eliminate lever sag

41 Degree Lever Rotation

Reduced lever rotation results in less wear / longer life

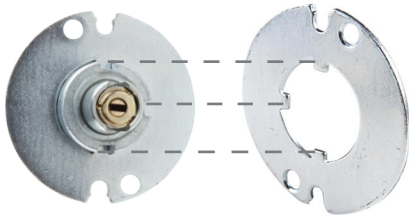

Heavy 13 gauge steel anti rotation plate is keyed to the chassis in 3 locations to resist the most extreme and abusive situations.

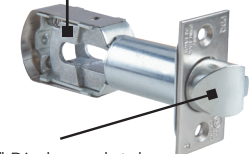
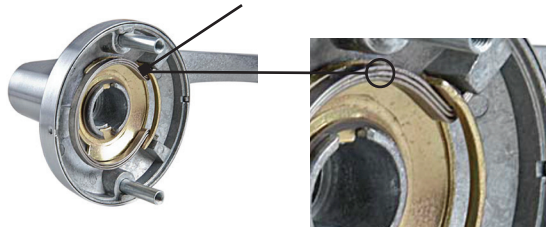

7/8" Dia brass latch bolt with 9/16" throw

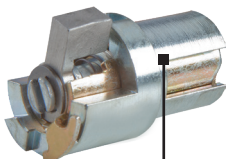

Oversize stainless steel locking tip and billet steel drives torque rating

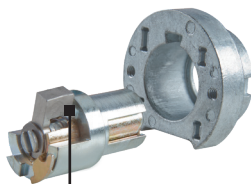

Thread lock patch(A) is standard on assembly and mounting fasteners keeps the lock body intact in the most challenging high use installations.

XGT SERIES

Extra Heavy Duty Cylindrical Lock

GRADE 1



- Super Strong – Rigid locked lever – No free wheeling lever or clutch
- 41 Degree Lever Rotation – less wear/longer life, most ADA Compliant on the market



Specifications

FOR DOORS:	• 1-3/4" to 2-1/4" thick • Preset for 1-3/4" door
APPLICATION:	• Through door thru-bolting
DOOR PREP:	• Standard ANSI A156.115 (161) for Cylindrical Locks
BACKSET:	• 2-3/4" Standard. 2-3/8", 3-3/4" and 5" Optional (Ordered from factory only). • Heavy duty diecast, investment cast, chromated cold rolled steel and stainless steel mechanism. Billet Steel spindles for locking functions
FRONT:	• 2-1/4" x 1-1/8" • Stainless Steel or Wrought Brass • Beveled 1/8" in 2"
STRIKE	• ASA standard • T-Strike or Full Lip Strike optional • Stainless Steel or Wrought Brass
LEVERS:	• Philadelphia (SFL and LFL), Boston (SFL), Miami (SFL)
ROSE:	• 3-3/8" DIA Wrought
LATCHBOLT:	• 9/16" Throw Deadlocking • 3/4" Latch projection for available as option.
HAND:	• Non-handed
TRIM:	• Solid diecast PHL, BSN or MIA Levers • 41° Lever Rotation Standard with 2-3/4" Backset • Wrought Brass Roses, Concealed Screws • 65° Lever Rotation Standard with 3/4" latch for double doors (Ordered from factory only) and all 2-3/8", 3-3/4" and 5" Backsets (Ordered from factory only)
KEYS:	• Two (2) per Lock
KEYWAYS	• SCC standard (Schlage C Compatible) • Also available in keyways of other manufacturers
INTERCHANGEABLE CORE:	• Available for all keyed functions • 6 or 7-pin • Large Format IC Core available for PHL Lever ONLY. • Compatible with Best, Falcon and Arrow small format IC cores
CYLINDER:	• 6-pin Brass Insert Cylinder keyed to 5-pins • Standard High Security and UL437 Cylinders Available
KEYING:	• Options: MK, CMK or GMK • Zero Bitted (KO), Keyed Different (KD) or Keyed Alike (KA) Can be keyed into existing master key systems
FINISHES:	• 605 (US3), 606 (US4), 612 (US10), 613E, 619 (US15), 622 (US19), 625 (US26), 626 (US26D) • Optional Antimicrobial Coating 626 (USD26D) only†
CERTIFICATIONS, LISTINGS, COMPLIANCES:	• UL listed for 3 hrs, for single doors up to 4'0" x 8'0". • Optional 3/4" (19mm) throw deadlocking fire latch (FRL) available for pairs of doors • Certified to ANSI/BHMA A156.2, Grade 1 • California Education Code Compliant (Functions XGT135, XGT135LED, XGT145) • Federal Specification FF-H-10C (Superseded by A156.2) • Approved for Florida HVHZ (High Velocity Hurricane Zone). PDQ Product Approval: FL 21376. Design load rating: ± 70.0 PSF for single door (3' x 7') • Complies with ADA (Americans with Disabilities Act) and ICC/ANSI 117.1 for Accessible and Usable Buildings
WARRANTY:	• Limited Lifetime Warranty
COUNTRY OF ORIGIN:	• Proudly Assembled in the U.S.A. with U.S. and foreign material. Meets requirements of the Buy American Act as a COTS product manufactured in the United States.

† Available with antimicrobial powder coating, treated with silver ionic technology that is known to inhibit the growth of microbes.

Trim/Levers

ALL LEVERS



GRADE 1



- Super Strong – Rigid locked lever
No free wheeling lever or clutch
- 41 Degree Lever Rotation – less wear/longer life,
most ADA Compliant on the market

Specifications



FOR DOORS:	• 1-3/4" to 2-1/4" thick • Preset for 1-3/4" door
APPLICATION:	• Through door thru-bolting
DOOR PREP:	• Standard ANSI A156.115 (161) for Cylindrical Locks
BACKSET:	• 2-3/4" Standard. 2-3/8", 3-3/4" and 5" Optional (Ordered from factory only).
CHASSIS:	• Heavy duty diecast, investment cast, chromated cold rolled steel and stainless steel mechanism. Billet Steel spindles for locking functions
FRONT:	• 2-1/4" x 1-1/8" • Stainless Steel or Wrought Brass • Beveled 1/8" in 2"
STRIKE	• ASA standard • T-Strike or Full Lip Strike optional • Stainless Steel or Wrought Brass
LEVERS:	• Philadelphia, Boston, Miami
ROSE:	• 3-3/8" DIA Wrought
LATCHBOLT:	• 9/16" Throw Deadlocking • 3/4" Latch projection for available as option.
HAND:	• Non-handed
TRIM:	• Solid diecast PHL, BSN or MIA Levers • 41° Lever Rotation Standard with 2-3/4" Backset • Wrought Brass Roses, Concealed Screws • 65° Lever Rotation Standard with 3/4" latch for double doors (Ordered from factory only) and all 2-3/8", 3-3/4" and 5" Backsets (Ordered from factory only)
KEYS:	• Two (2) per Lock
KEYWAYS	• SCC standard (Schlage C Compatible) • Also available in keyways of other manufacturers
INTERCHANGEABLE CORE:	• Available for all keyed functions • 6 or 7-pin • Large Format IC Core available for PHL Lever ONLY. • Compatible with Best, Falcon and Arrow small format IC cores
CYLINDER:	• 6-pin Brass Insert Cylinder keyed to 5-pins • Standard High Security and UL437 Cylinders Available
KEYING:	• Options: MK, CMK or GMK • Zero Bitted (KO), Keyed Different (KD) or Keyed Alike (KA) Can be keyed into existing master key systems
FINISHES:	• 605 (US3), 606 (US4), 612 (US10), 613E, 619 (US15), 622 (US19), 625 (US26), 626 (US26D) • Optional Antimicrobial Coating 626 (USD26D) only‡
CERTIFICATIONS, LISTINGS, COMPLIANCES:	• UL listed for 3 hrs, for single doors up to 4'0" x 8'0" • Optional 3/4" (19mm) throw deadlocking fire latch (FRL) available for pairs of doors • Certified to ANSI/BHMA A156.2, Grade 1 • California Education Code Compliant (Functions GT135, GT135LED, GT145) • Federal Specification FF-H-10C (Superseded by A156.2) • Approved for Florida HVHZ (High Velocity Hurricane Zone). PDQ Product Approval: FL 21376. Design load rating: ± 70.0 PSF for single door (3' x 7') • Complies with ADA (Americans with Disabilities Act) and ICC/ANSI 117.1 for Accessible and Usable Buildings
WARRANTY:	• Twenty-five (25) year Limited Warranty
COUNTRY OF ORIGIN:	• Proudly Assembled in the U.S.A. with U.S. and foreign material. Meets requirements of the Buy American Act as a COTS product manufactured in the United States.

‡ Available with antimicrobial powder coating, treated with silver ionic technology that is known to inhibit the growth of microbes.

Trim/Levers



ALL LEVERS



PHILADELPHIA – PHL



SFL



LFL



BOSTON – BSN



SFL



MIAMI – MIA



SFL

GRADE 1

Red Led Indicator Confirms the Door is Locked



Outside Lever Unlocked



To Check the Security of the Outside Lever, Press the Button. If the Red Led Lights Up, that Confirms the Outside Lever is Locked and Secure.

Easy-to-Read LED Indicator Confirms the Door is Locked.

XGT/GT 135 LED Classroom Intruder Cylindrical Lock is designed to allow a staff member to use the inside cylinder to lock the outside of the door, without compromising safety to the occupants in the room. But how does a staff member know if the outside lever is locked?



Until now, it required opening the door and checking the lever. PDQ's 135 LED Classroom Intruder function eliminates the need to open the door. Simply press the button on the lock, and...if the Red LED lights up, the outside lever is locked and secure. If the Red LED does not light up, this indicates the outside lever is not locked and secure.

Features



- Complies with California Education Code (Functions GT135, GT135LED, GT145)
- Red LED (Light Emitting Diode) outside lever status indicator.
- Pushing the button located on the rose of the inside lock, Red LED illuminates indicating the outside lever is locked.
- Offered with cylinder housings compatible with Best® Small Format Inter-changeable cores, Schlage® Large Format Interchangeable cores and most others.
- Large Format Inter-changeable cores only available with PHL lever.
- Keying options available, compatible with most key systems.
- Battery life rating: 10 years*
- Battery type: CR1220
- Patented (US Patent #9,187,928)
- Factory tested to over 2 million cycles (2 times the ANSI/BHMA Grade 1 std)
- Lever torque tested to 2,100 in-lbs (3 times the ANSI/BHMA Grade 1 std)

Status Indicator Locks

GT135LED

GT135

GT145

Time Out Locks

GT173

School Security Functions

Vestibule Class Room Security with LED Status Indicator

Vestibule Class Room Security without LED Status Indicator

Vestibule Class Room Security with Lock Directional Arrow (No LED Indicator)

Time Out Lock

GRADE 1

Typical Applications

- Apartments
- Back-of-House Hotel/Motel
- Commercial Buildings
- Government Buildings
- High Traffic Areas
- Healthcare
- Houses of Worship
- Military Barracks
- Retail Backroom
- Retrofit/Repair/Replacement

Features

- UL listed for 3-hour fire door
- Exceeds ANSI/BHMA A156.2 Grade 1
- 5 standard functions
- Various strike and latch options to accommodate any opening
- Available in keyways of most major manufacturers
- Tactile abrasive coating option
- Antimicrobial coating option
- Five (5) year limited warranty

Designed for Robust Applications



Specifications

FOR DOORS:	• 1-3/8" to 2" thick.
DOOR PREP:	• Fits Standard 160 or 161 Door Prep.
BACKSET:	• 2-3/8", 2-3/4", 3-3/4", 5".
CASE:	• Steel, Yellow Chromate Plate
FRONT:	• 2-1/4" x 1-1/8" or 2-1/4" x 1" • Stainless Steel or Wrought Bronze.
STRIKE:	• 4-7/8" x 1-1/4" (ASA). "T" or "FL" Strike Optional. • Stainless Steel or Wrought Bronze.
UL F LATCHBOLT:	• 3 hours of fire testing qualified, stainless steel latch bolt.
ROSE:	• 3" DIA Wrought.
HAND:	• Non-handed.
TRIM:	• CQ ball knob. Stainless steel or wrought brass.
KEYWAYS:	• Available in keyways of most major manufacturers.
CYLINDER:	• Supplied standard to accommodate SFIC core. (Cylinder not included). • Standard High Security and UL437 Cylinders Available
KEYING:	• Standard core is available and can be MK, CMK, GMK, or CK. Available Zero Bitted (KO), Keyed Different (KD), Keyed Alike (KA). Can be keyed into existing masterkey systems of other manufacturers.
FINISHES:	• 630 (US32D)
WARRANTY:	• Five (5) Year Limited Warranty
CERTIFICATIONS, LISTINGS, COMPLIANCES:	• Meets ANSI/BHMA A156.2-2003 Grade 1, surpassed 800,000 cycles • UL/CUL 10C listed for 3 hrs, for single doors up to 4'0" x 8'0" • TAA compliant. Country of origin: Taiwan

‡ Available with antimicrobial coating, technology that is known to inhibit the growth of microbes.

Durability and Reliability

PDQ's Grade 2 mechanical lock offering includes a range of features, functions, and styles as well as a commitment to deliver durability, convenience, and unmatched value for a wide range of projects and applications.

GP Mechanical

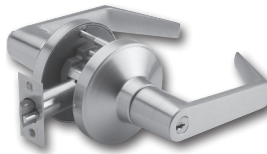

Applications

Heavy-duty performance for high-traffic interior and exterior applications including offices, hospitality, assisted living, church, and other high/medium duty commercial applications. Strong like an ox, over 3x BHMA abusive lever torque test standard.

SD Mechanical

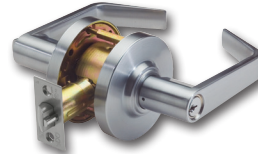

Applications

Built to offer tough and reliable performance at a competitive price. Applications include multi-family, offices, hospitality, assisted living, and other standard duty commercial applications.

SF Mechanical

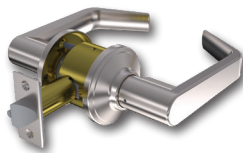

Applications

Built to offer tough and reliable performance at a competitive price. Applications include multi-family, offices, hospitality, assisted living, and other standard duty commercial applications.

CL Interconnected

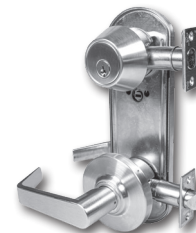

Applications

Offers the security of a deadbolt and lever combined in one product. Applications include hospitality, assisted living, multi-family, offices and retail.

Grade 1 Strength at a Grade 2 Price

- Super Strong — Rigid locked lever — No free wheeling lever or clutch
- Versatile — Trim matches XGT/GT Grade 1 locks

Typical Applications

- Government Facilities
- Healthcare
- Higher Education
- Hospitality
- Houses of Worship
- Industrial
- K-12 Education
- Multi-family
- Offices
- Public Buildings

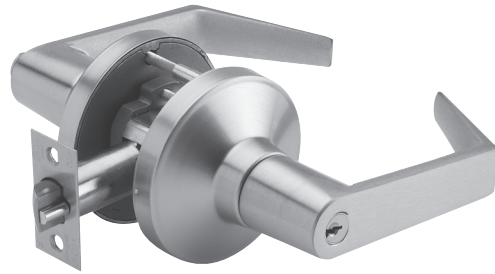

Specifications

FOR DOORS:	• 1-3/8" to 1-3/4" thick • Preset for 1-3/4" door
APPLICATION:	• Through door thru-bolting • Fits 160 and 161 Door prep
BACKSET:	• 2-3/4" standard • 2-3/8", 5" optional
CHASSIS:	• Heavy duty diecast, investment cast, cold rolled steel, stainless steel mechanism
FRONT:	• 2-1/4" x 1-1/8" or 2-1/4" x 1" • Stainless Steel or Wrought Brass • Beveled 1/8" on 2"
STRIKE:	• ASA standard • Stainless Steel or Wrought Brass • T-Strike or Full Lip Strike optional
LEVERS:	• Philadelphia, Boston, Miami
ROSE:	• 3-3/8" DIA Wrought
LATCHBOLT:	• 1/2" Throw
HAND:	• Non-handed
TRIM:	• Solid diecast PHL, BSN or MIA Levers • 65° Lever Rotation • Wrought Brass Roses • Concealed Screws
KEYS:	• Two (2) per Lock
KEYWAYS:	• SCC standard (Schlage C Compatible) • Compatible with Best, Falcon and Arrow small format IC cores
INTERCHANGEABLE CORE:	• Available for all keyed functions • Large Format IC Core available for PHL Lever ONLY. For other lever shapes, contact PDQ Customer Service. • 6 or 7-pin • Compatible with Best, Falcon & Arrow
CYLINDER:	• 6-pin Brass Insert Cylinder keyed to 5-pins • Standard High Security and UL437 Cylinders Available
KEYING:	• Options: MK, CMK or GMK • Zero Bitted (KO), Keyed Different (KD) or Keyed Alike (KA) Can be keyed into existing master key systems
FINISHES:	• 605 (US3), 606 (US4), 612 (US10), 613E, 619 (US15), 622 (US19), 625 (US26), 626 (US26D) • Optional Antimicrobial Coating with 626 finish only.
CERTIFICATIONS, LISTINGS, COMPLIANCES:	• UL listed for 3 hrs, for single doors up to 4'0" x 8'0" • Certified to ANSI/BHMA 156.2, Grade 2 • Complies with ADA (Americans with Disabilities Act) and ICC/ANSI 117.1 for Accessible and Usable Buildings
WARRANTY:	• Eight (8) Year Limited Warranty
COUNTRY OF ORIGIN:	• Assembled in the U.S.A. with U.S. and foreign material. • Meets requirements of the Buy American Act as a COTS product manufactured in the United States.

‡ Available with antimicrobial coating, technology that is known to inhibit the growth of microbes.

GRADE 2

Most Valuable Grade 2 on the Market

- 8 Functions, more than most other Grade 2 locks
- Removable through bolts make for easy installation
- Designer lever and finish styles plus a 5-Year Warranty

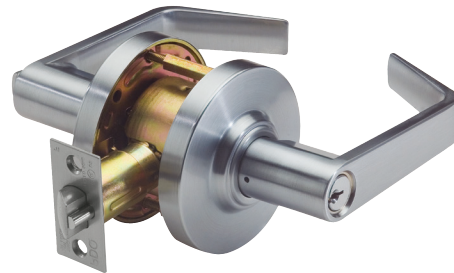

Typical Applications

- Assisted Living
- Hospitality
- Houses of Worship
- Industrial
- Medium/Light Commercial Installations
- Multi-family
- Offices
- Retail

Specifications



FOR DOORS:	• 1-3/8" to 1-3/4" thick • Preset for 1-3/4" door
APPLICATION:	• Through door thru-bolting • Fits standard 160 and 161 Door prep • Thru-Bolts are removable
BACKSET:	• 2-3/4" standard • 2-3/8", 3-3/4", 5" optional
CHASSIS:	• Heavy-gauge cold rolled steel mechanism • Dichromated for corrosion resistance
FRONT:	• 2-1/4" x 1-1/8" or 2-1/4" x 1" • Beveled 1/8" on 2" • Stainless Steel or Wrought Brass
STRIKE:	• ASA standard • T-Strike or Full Lip Strike optional • Stainless Steel or Wrought Brass
LEVERS:	• Philadelphia, Boston, Miami, Memphis, Orlando
ROSE:	• 3-3/8" DIA Wrought
LATCHBOLT:	• 1/2" Throw
HAND:	• Non-handed (Except Memphis)
TRIM:	• Solid diecast PHL, BSN, MIA, MEM and ORL Levers • Wrought Brass Roses • Concealed Screws
KEYS:	• Two (2) per Lock
KEYWAYS:	• SCC standard (Schlage C Compatible) • Also available in keyways of other manufacturers
INTERCHANGEABLE CORE:	• 6 or 7-pin • Compatible with Best, Falcon & Arrow. Not available with Memphis lever.
CYLINDER:	• 6-pin Brass Insert Cylinder keyed to 5-pins • Standard High Security and UL437 Cylinders Available
KEYING:	• Options: MK, CMK or GMK / Zero Bitted (KO), Keyed Different (KD) or Keyed Alike (KA) • Can be keyed into existing master key systems
FINISHES:	• 605 (US3), 613E, 622 (US19), 622 (19D), 626 (US26D)
CERTIFICATIONS, LISTINGS, COMPLIANCES:	• UL listed for 3 hrs, for single doors up to 4'0" x 8'0" • Certified to ANSI/BHMA A156.2 Grade 2 • Complies with ADA (Americans with Disabilities Act) and ICC/ANSI 117.1 for Accessible and Usable Buildings • TAA compliant. Country of origin: KR
WARRANTY:	• Five (5) year Limited Warranty

‡ Available with antimicrobial coating, technology that is known to inhibit the growth of microbes.

GRADE 2

Reliable Security for Multi-Family, Multi-Tenant and Light Commercial Applications.

- 5 functions - Privacy, Passage, Entrance Storeroom plus Single Dummy
- Heavier duty cylindrical lock is more durable than a tubular lock
- 5 designer levers to choose from
- 7 architectural finishes
- Stylish 2-9/16" round rose and 2-15/16" square rose
- Retrofits all major manufacturer's door preps
- Adjustable 2-3/8" - 2-3/4" backset latch is standard.
- Optional fixed backset latch adds fire label and BHMA certification.
- Conventional and SFIC core cylinders.
- Anti-lockout kick-off feature (Privacy)
- Suitable for doors 1-3/8" - 1-3/4" thick
- Shares common levers with SD Cylindrical and CL Interconnected locks.
- Mix and match for a uniform look.



Typical Applications

- Assisted Living
- Hospitality
- Houses of Worship
- Industrial
- Medium/Light Commercial Installations
- Multi-family
- Offices
- Retail



ADA COMPLIANT

Specifications

FOR DOORS:	• 1-3/8" to 1-3/4" thick • Preset for 1-3/4" door
APPLICATION:	• Fits standard 160 and 161 door prep • No additional thru-bolt
BACKSET:	• Adjustable - 2-3/8" - 2-3/4" (Optional UL Listed fire latch has fixed backsets, 2-3/8" or 2-3/4")
CHASSIS:	• Heavy-gauge cold rolled steel mechanism • Dichromated for corrosion resistance
FRONT:	• 1" face width, 1/4" radius with square corner filler for 1-1/8" width.
STRIKE:	• Full Lip Strike standard, ASA and T-Strike optional
LEVERS:	• Philadelphia, Boston, Miami, Memphis and Orlando
ROSE:	• 2-9/16" Diameter Round Rose, 2-15/16" Square Rose
LATCHBOLT:	• Adjustable - 2-3/8" - 2-3/4" latch standard, Optional UL fire-rated 2-3/4" or 2-3/8" fixed latchbolts are available.
HAND:	• Non-handed, for Memphis, swap levers to rehand.
TRIM:	• Solid diecast PHL, BSN, MIA, MEM and ORL levers • Wrought brass roses • Concealed screws
KEYS:	• Two (2) per Lock
KEYWAYS:	• SCC standard (Schlage C Compatible) • Also available in keyways of other manufacturers
INTERCHANGEABLE CORE:	• 6 or 7-pin • Compatible with Best, Falcon & Arrow. Not available with Memphis lever.
CYLINDER:	• 6-pin Brass Insert Cylinder keyed to 5-pins • Standard High Security and UL437 Cylinders Available
KEYING:	• Options: MK, CMK or GMK / Zero Bitted (KO), Keyed Different (KD) or Keyed Alike (KA) • Can be keyed into existing master key systems
FINISHES:	• 605 (US3), 606 (US4), 613E, 619 (US15), 622 (US19), 625 (US26), 626 (US26D)
COMPLIANCES:	• Complies with ADA (Americans with Disabilities Act) and ICC/ANSI 117.1 for Accessible and Usable Buildings
CERTIFICATIONS, LISTINGS:	• Entry function and optional fixed backset latch only. - Certified to ANSI/BHMA 156.2, Grade 2 (fixed backset latch only). - UL listed for single doors up to 40" x 8'0" when ordered with UL latchbolt, contact factory for details. • TAA compliant. Country of origin: KR
WARRANTY:	• Three (3) year Limited Warranty

GRADE 2

Security of a Deadbolt and Lever in One Assembly

- Field selectable prep – 4" and 5-1/2" hole centers
- CL and SD cylindricals share common levers.
Match them for entry and interior doors to achieve a coordinated look.

Typical Applications

- Assisted Living
- Hospitality
- Military Housing
- Multi-family
- Offices
- Retail

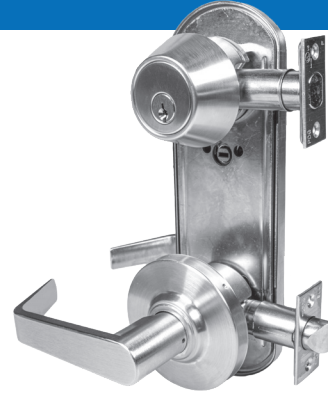

ADA COMPLIANT

Specifications

FOR DOORS:	• 1-3/8" and 1-3/4" thick.
PREPARATION:	• ANSI/BHMA A156.115 for 4" and 5-1/2" hole centers, field selectable.
DUST BOX:	• Included for Latchbolt and Deadbolt.
LATCHBOLT BACKSET:	• 2-3/8" or 2-3/4" (Default). Specify when ordering
DEADBOLT BACKSET:	• Field adjustable for 2-3/8" and 2-3/4" (Default).
STRIKE:	• "T"-Strike (Default) • ASA or Full-Lip optional
LEVERS:	• Boston, Miami, Memphis, Orlando, Philadelphia
ROSE:	• 2-3/8" Round Rose, 2-15/16" Square Rose
INSIDE ESCUTCHEON:	• 3-3/4"W x 9-3/4"H (Wrought)
LATCHBOLT:	• 1/2" Throw
DEADBOLT:	• ADA compliant.
HANDING:	• Non-handed (Except for Memphis Lever)
KEYS:	• Two (2) per Lock
KEYWAYS:	• SCC Default (Schlage C Compatible). For additional keyways, see Cylinders and Keying section.
INTERCHANGEABLE CORE:	• 6-pin or 7-pin • Compatible with Best SFIC. • Not available in high security.
CONVENTIONAL KEY IN KNOB/ LEVER CYLINDER:	• 6-pin Cylinder keyed to 5-pins
KEYING:	• Options: MK, CMK, or GMK, Zero Bitted (KO), Keyed Different (KD) or Keyed Alike (KA) • Can be keyed into existing master key systems. See Keyways Section.
FINISHES:	• 605 (US3), 613E, 622 (US19), 626 (US26D) (See Note)
CERTIFICATIONS, LISTINGS, COMPLIANCES:	• ANSI, Grade 2 • UL listed for 3 hrs, for single doors up to 4'0" x 8'0" • Complies with ADA (Americans with Disabilities Act) and ICC/ANSI 117.1 for Accessible and Usable Buildings • TAA compliant. Country of origin: KR
WARRANTY:	• Two (2) year Limited Warranty

NOTE: OTHER FINISHES AVAILABLE. CONTACT CUSTOMER SERVICE FOR QUOTE AND LEAD-TIME.

GRADE 2

Perfect for Commercial Duty Applications

Typical Applications

- Apartments
- Back-of-House Hotel/Motel
- Heavy-Duty Residential
- Houses of Worship
- Medium Traffic Commercial Applications
- Offices
- Retail Backroom
- Retrofit/Repair/Replacement
- Warehouses

Features

- UL listed for 3-hour fire door
- Exceeds ANSI/BHMA A156.2 Grade 2
- 10 standard functions
- Various strike and latch options to accommodate any opening
- Available in keyways of most major manufacturers
- Tactile abrasive coating option
- Antimicrobial coating option
- One (1) year limited warranty



Specifications



FOR DOORS:	• 1-3/8" to 1-3/4" thick
BACKSET:	• 2-3/4" standard • 2-3/8", 5" optional
FRONT:	• 2-1/4" x 1-1/8" or 2-1/4" x 1" • Stainless Steel or Wrought Brass
STRIKE:	• 4-7/8" x 1-1/4" (ASA). "T" or "FL" Strike optional. Stainless steel or wrought bronze.
ROSE:	• 3" DIA Wrought
LATCHBOLT:	• 1/2" throw. Solid brass. Adjustable for beveled doors.
HAND:	• Non-handed
KEYS:	• Two change keys per lock.
KEYWAYS:	• Available in keyways of most major manufacturers.
CYLINDER:	• Brass 6-pin cylinder keyed to 5 pins. • Standard High Security and UL437 Cylinders Available
TRIM:	• Stainless Steel or Wrought Brass Knobs and Roses
KEYING:	• Can be MK, CMK, GMK, or CK. Available Zero Bitted (KO), Keyed Different (KD), Keyed Alike (KA). Can be keyed into existing masterkey systems of other manufacturers.
FINISHES:	• 630 (US32D) • Optional Antimicrobial Coating available
WARRANTY:	• One (1) Year Limited Warranty
CERTIFICATIONS, LISTINGS, COMPLIANCES:	• Certified to ANSI/BHMA A156.2, Grade 2 • UL/CUL 10C listed for 3 hrs, for single doors up to 4'0" x 8'0" • TAA compliant. Country of origin: KR

Non-Keyed Companion to MR Mortise Lock

- Shares common high-end trim and levers with MR Mortise
- TJ/MR combination delivers a uniform look throughout apartment

Features

- Contemporary decorative trim perfect for high end residential and office work
- Designed to compliment MR Series Mortise locks sharing the same sectional rose diameter and levers
- Investment cast stainless steel trim
- Range of lever styles available
- Available in round rose or square rose
- Uses a slender 1-3/8" diameter rose providing a clean contemporary look

Typical Applications

- High-End Residential
- Multi-family
- Offices

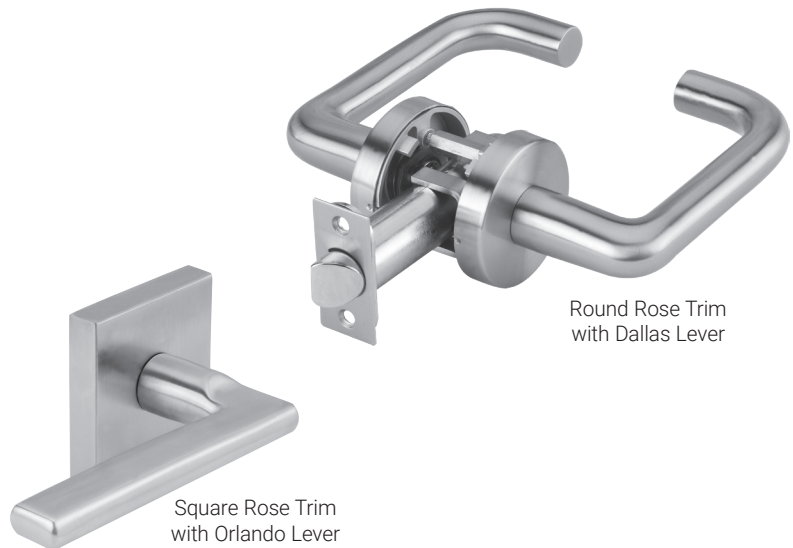

Specifications



FOR DOORS:	• For doors 1-3/8" (35mm) to 1-3/4" (44mm) thick standard
BACKSET:	• 2-3/4" (70mm) default. Optional: 2-3/8" (60mm);
STRIKE:	• "Full Lip" strike default. "T" strike and ANSI/ASA strike optional
ROSE DIMENSIONS:	• Round Rose: 2-3/8" DIA • Square Rose: 2-9/16"
DOOR PREP:	• ANSI Standard 115.2, Type 161 for 2-3/4" Backset • Type 160 optional
LATCH BOLTS:	• 2-3/4" Backset has 1-1/8" faceplate. 2-3/8" Backset has a 1" faceplate filler
HAND:	• Non-handed, except Memphis and Orlando
FINISHES:	• 605 (US3) Bright Brass, 606 (US4) Satin Brass, 612 (US10) Satin Bronze, 613E Dark Oxidized Satin Bronze, 622 (US19) Flat Black, 629 (US32) Bright Stainless Steel, 630 (US32D) Satin Stainless Steel
TRIM:	• Stainless Steel Levers and Roses
LEVER DESIGNS:	• Philadelphia, Boston, Miami, Chicago, Houston, Memphis, Orlando, Los Angeles, Dallas and Ball Knob.
CERTIFICATIONS, LISTINGS, COMPLIANCES:	• Complies with ADA (Americans with Disabilities Act) and ICC/ANSI 117.1 for Accessible and Usable Buildings
WARRANTY:	• Five (5) year limited warranty (except ball knob)

XGT/ GT199A Series

Electrified Cylindrical Lock

BHMA GRADE 1



Flexible Design Accommodates Multiple Voltages

- Universal input voltage: 12/24V both AC and DC, out-of-the box
- FAIL SECURE/FAIL SAFE is field selectable
- Get the job done right on the first visit

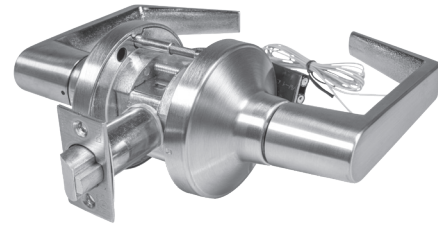

Typical Applications

- Computer Rooms
- High Security Areas
- Pharmacies
- Stairwell Towers
- Tenant Spaces

Specifications



PERFORMANCE:	<ul style="list-style-type: none"> • Motor drive factory tested to over 1.4 million cycles (1.4 times the ANSI/BHMA grade 1 std).
RECOMMENDED POWER SUPPLY:	<ul style="list-style-type: none"> • PDQ Model # 81440. <ul style="list-style-type: none"> – Input: 120VAC, .9A, 50/60Hz 240VAC, .6A, 50/60Hz – Output: 24VDC, 2A, filtered and regulated. • Rated for simultaneous operation of 2ea mortise lock assemblies. • Power Supply Requirements: <ul style="list-style-type: none"> – AC/DC Output Voltage – 1A min (filtered and regulated). • 12-24VDC @ < 1A initial surge (1 sec), 5mA standby after 30 sec. – AC Output Voltage. • 12-24VAC (60Hz) @ < 1A initial surge (1 sec), 15mA standby after 30 sec
ELECTRICAL SPECIFICATIONS:	<ul style="list-style-type: none"> • Input voltage: 12-24VDC or 12-24VAC. • Max In-rush current: 1.0A. • Standby current: <ul style="list-style-type: none"> – 12VAC: 12mA. – 24VAC: 10mA. – 12VDC: 3mA. – 24VDC: 5mA. <p>Note: Operating voltage at ± 10% of rated voltage.</p>
CERTIFICATIONS, LISTINGS, COMPLIANCES:	<ul style="list-style-type: none"> • ANSI/UL10C and CAN/ULC-5104 Listed for "Fire Exit Hardware" up to 3 hours for 4'0" x 8'0" maximum single, 8'0" x 8'0" maximum pairs. • Assembled in the U.S.A. with U.S. and foreign material. Meets requirements of the Buy American Act as a COTS product manufactured in the United States.
WARRANTY:	<ul style="list-style-type: none"> • 25-Years Mechanical / 2-Years Electronic

Trim/Levers



PHILADELPHIA – PHL



SFL



LFL



BOSTON – BSN



SFL



MIAMI – MIA



SFL

Secure. Durable. Versatile.

Deadbolts are often paired with a cylindrical lock in commercial office spaces, residential applications and other spaces where there is a greater need for security—and, more specifically, a deadbolt that is more resistant to brute force attack. PDQ deadbolts provide security for a wide range of applications while allowing end users to meet their specific security needs.

KM Heavy Duty Rim Cylinder



Applications

Heavy duty performance. Ideal for commercial, institutional, government, military, hospitality, hospital, multi-family, offices, and retail applications. Typical installations include storerooms, auxiliary entrance locks, communication doors in hotels, and aluminum storefronts.

KT Extra Heavy Duty Mortise Cylinder

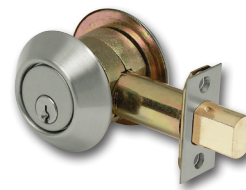

Applications

Heavy duty performance. Ideal for commercial, institutional, government, military, hospitality, hospital, multi-family, offices, and retail applications.

KV Commercial Duty Rim Cylinder



Applications

Standard duty performance, ideal for light commercial and residential applications.

MJ Extra Heavy Duty Mortise Cylinder



Applications

Small body deadbolt provides an extra measure of protection at a competitive price. Uses include common areas, auxiliary doors, closets, storerooms, and equipment rooms in commercial, institutional and military applications.

Safety. Security. Peace of Mind.

Typical Applications

- Auxiliary Doors
- Closets
- Commercial/Institutional/Military
- Common Areas
- Equipment Rooms
- Storerooms
- Restrooms
- Privacy Rooms



Standard
Thumbturn



Indicator



Cylinder

Specifications

Small Mortise Body Type Prep



FOR DOORS:	• 1-3/4"
BACKSET:	• 2-3/4"
CASE:	• Steel – Dichromated for corrosion resistance
FACEPLATE:	• 1-1/4" x 5-5/8"
FRONT:	• 2-1/4" x 1" • Stainless Steel.
STRIKE	• 1-1/8" x 3-1/2"
DEADBOLT:	• 1" Throw. • Stainless Steel.
THUMBTURN OPTION:	• ADA Compliant.
INDICATOR:	• Vacant/Occupied available.
HAND:	• Non-handed except for function MJ134 Classroom. (See Function Table and How to Order Guide).
KEYS:	• Two (2) per Lock.
KEYWAYS:	• SCC standard (Schlage C Compatible) • Also available in keyways of other manufacturers
INTERCHANGEABLE CORE:	• 6 or 7-pin • Compatible with Best, Falcon & Arrow • Large Format IC Cores compatible with Schlage.
CYLINDER:	• 6 or 7-pin Mortise Cylinder
KEYING:	• Options: MK, CMK or GMK • Zero Bitted (KO), Keyed Different (KD) or Keyed Alike (KA) • Can be keyed into existing master key systems
FINISHES:	• 605 (US3), 606 (US4), 612 (US10), 613E, 622 (US19), 629 (US32), 630 (US32D)
CERTIFICATIONS, LISTINGS, COMPLIANCES:	• UL listed for 3 hours, for single doors up to 4'0" x 8'0" • TAA compliant. Country of origin: Taiwan
WARRANTY:	• 10-Year Limited Warranty

COMMERCIAL GRADE

Deadbolt is Grade Comparable with XGT and GT Series Grade 1 Cylindrical Locks

Typical Applications

- Commercial
- Government
- Hospitality
- Institutional
- Military
- Multi-family
- Offices
- Retail

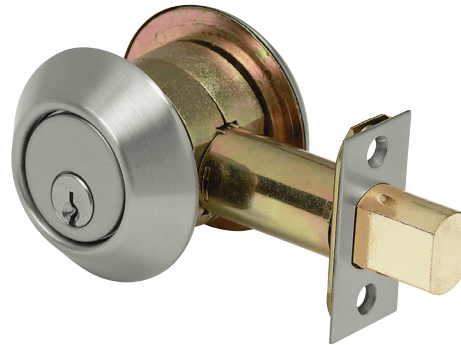

Specifications

FOR DOORS:	• 1-3/4" thick standard, contact factory for other thicknesses
DOOR PREP:	• 2-1/8" DIA
BACKSET:	• 2-3/4" (Default) • 2-3/8" available
FRONT:	• 2-1/4" x 1-1/8" or 2-1/4" x 1" • Stainless Steel or Wrought Brass
STRIKE:	• 2-3/4" x 1-1/8" • Stainless Steel or Wrought Brass • Dust Box Included
DEADBOLT:	• 1" Throw • Brass Bolt containing two concealed 1/4" case-hardened Steel Roll Pins
HAND:	• Non-handed
TRIM:	• Wrought Brass Scalp • Reinforced Zinc Diecast Rose
KEYS:	• Two (2) per Lock
KEYWAYS:	• SCC standard (Schlage C Compatible) • Also available in keyways of other manufacturers
CYLINDER:	• 6-pin Brass Mortise Cylinder keyed to 5-pins, SFIC
KEYING:	• Options: MK, CMK or GMK • Zero Bitted (KO), Keyed Different (KD) or Keyed Alike (KA) • Can be keyed into existing master key systems
FINISHES:	• 605 (US3), 606 (US4), 612 (US10), 613E, 625 (US26), 626 (US26D)
WARRANTY:	• One (1) year Limited Warranty
LISTINGS:	• UL 10C listed, 3-hour fire rated as auxiliary locks for A label single doors • UL 10B listed for neutral pressure doors

COMMERCIAL GRADE

Deadbolt is Grade Comparable with GP and SD Series Grade 2 Cylindrical Locks

Typical Applications

- Commercial
- Government
- Hospitality
- Institutional
- Military
- Multi-family
- Offices
- Retail



ADA COMPLIANT

Specifications

FOR DOORS:	• 1-3/8" to 1-3/4" thick for Conventional Cylinder, 1-1/2" to 2" for SFIC
DOOR PREP:	• 2-1/8" DIA
BACKSET:	• 2-3/4" - 2-3/8" adjustable (Default) • 2-3/4" (Option) • 2-1/4" x 1" faceplate available
FRONT:	• 2-1/4" x 1-1/8" • Stainless Steel or Wrought Brass
STRIKE:	• 2-3/4" x 1-1/8" • Stainless Steel or Wrought Brass • Dust Box Included
DEADBOLT:	• 1" Throw • Brass Bolt containing one 1/4" case-hardened Steel Roll Pin
THUMBTURN:	• ADA Compliant
HAND:	• Non-handed
TRIM:	• Stainless Steel or Wrought Brass Scalp • Reinforced Zinc Diecast Rose
KEYS:	• Two (2) per Lock
KEYWAYS:	• SCC standard (Schlage C Compatible) • Also available in keyways of other manufacturers
INTERCHANGEABLE CORE:	• 6 or 7-pin • Compatible with Best, Falcon and Arrow
CYLINDER:	• 6-pin Brass RIM Cylinder keyed to 5-pins • Standard High Security and UL437 Cylinders Available
KEYING:	• Options: MK, CMK or GMK • Zero Bitted (KO), Keyed Different (KD) or Keyed Alike (KA) • Can be keyed into existing master key systems
FINISHES:	• 605 (US3), 606 (US4), 613E, 622 (US19), 626 (US26D), 630 (US32D)
CERTIFICATIONS, LISTINGS, COMPLIANCES:	• UL 10C listed, 3-hour fire rated as auxiliary locks for A label single doors • UL 10B listed for neutral pressure doors • Complies with ADA (Americans with Disabilities Act) and ICC/ANSI 117.1 for Accessible and Usable Buildings • TAA compliant. Country of origin: KR
WARRANTY:	• One (1) year Limited Warranty

COMMERCIAL GRADE

Deadbolt is Grade Comparable with GP and SD Series Grade 2 Cylindrical Locks

Typical Applications

- Light Commercial Installations
- Low Security Applications
- Residential



Specifications



FOR DOORS:	• 1-3/8" to 1-3/4" thick for Conventional Cylinder, 1-1/2" to 2" for SFIC
DOOR PREP:	• 2-1/8" DIA
BACKSET:	• 2-3/4"/2-3/8" adjustable (Default)
FRONT:	• 2-1/4" x 1" with filler plate • Stainless Steel or Wrought Brass
STRIKE:	• 2-3/4" x 1" • Stainless Steel or Wrought Brass • Dust Box Included
DEADBOLT:	• 1" Throw • Brass Bolt containing one 1/4" case-hardened Steel Roll Pin
HAND:	• Non-handed
TRIM:	• Stainless Steel or Wrought Brass Scalp
KEYS:	• Two (2) per Lock
KEYWAYS:	• SCC standard (Schlage C Compatible) • Also available in keyways of other manufacturers
INTERCHANGEABLE CORE:	• 6 or 7-pin • Compatible with Best, Falcon and Arrow
CYLINDER:	• 6-pin Brass Insert Cylinder keyed to 5-pins • Standard High Security and UL437 Cylinders Available
KEYING:	• Options: MK, CMK or GMK • Zero Bitted (KO), Keyed Different (KD) or Keyed Alike (KA) • Can be keyed into existing master key systems
FINISHES:	• 605 (US3), 606 (US4), 612 (US10), 613E, 622 (US19), 629 (US32), 630 (US32D)
CERTIFICATIONS, LISTINGS, COMPLIANCES:	• ANSI "Positive Pressure Fire Tests of Door Assemblies" for up to and including 3 hrs. Assemblies" for up to and including 3 hrs. • Complies with ADA (Americans with Disabilities Act) and ICC/ANSI 117.1 for Accessible and Usable Building • UL 10C listed, 3-hour fire rated as auxiliary locks for A label single doors • UL 10B listed for neutral pressure doors • TAA compliant. Country of origin: KR
WARRANTY:	• One (1) year Limited Warranty

Keying

		MORTISE		CYLINDRICAL						INTERCONNECTED	
		MR	MJ	XGT	GT	GP	SD	SX	SV	CL	
KEYS	2 per lock	•	•	•	•	•	•	•	•	•	•
KEYWAYS	SCC Standard (Schlage compatible)	•	•	•	•	•	•	•	•	•	•
	Available in keyways of other manufacturers	•	•	•	•	•	•	•	•	•	•
SFIC	6 or 7 pin	•	•	•	•	•	•	•	•	•	•
	Available for all keyed functions	•	•	•	•	•	•	•	•	•	•
	Compatible with all SFIC.	•	•	•	•	•	•	•	•	•	•
CYLINDER	Large format IC core compatible with Schlage (Only)	•	•	•	•	•					
	5 or 6 pin brass mortise cylinder	•	•								
KEYING	6 pin brass insert cylinder keyed to 5 pins			•	•	•	•		•		•
	Options: MK, CMK, or GMK	•	•	•	•	•	•	•	•	•	•
	Zero Bitted (KO), Keyed Different (KD), or Keyed Alike (KA)	•	•	•	•	•	•	•	•	•	•
	Can be keyed into existing master key systems	•	•	•	•	•	•	•	•	•	•

Keyway Availability

CONVENTIONAL CYLINDER		SMALL FORMAT INTERCHANGEABLE CORE		LARGE FORMAT INTERCHANGEABLE CORE	
KEYWAY	PDQ KEYWAY DESIGNATOR	KEYWAY (BEST COMPATIBLE)	PDQ KEYWAY DESIGNATOR	KEYWAY (SCHLAGE COMPATIBLE)	PDQ KEYWAY DESIGNATOR
Schlage C (Default)	SCC	BEST A (Default), B, C, D, E, F, G, H, J, K, L, M, Q, R, WA, WB, WG, WH, TB, TD, TE, R	A (Default), B, C, D, E, F, G, H, J, K, L, M, Q, R, WA, WB, WG, WH, TB, TD, TE, R	Schlage C (Default)	SCC
PDQ Restricted	TA			PDQ Restricted	TA
Arrow AR1	AR1			PDQ1	
Corbin 59A1	CO59A1			PDQ2	
Corbin 60	CO6			PDQ3	
Corbin L4	CL4				
Russwin D1	RUD				
Russwin 981	RUD981				
Schlage E	SCE				
Schlage C	SCC				
Schlage C-K	SCC-K				
Sargent LA	SAL				
Sargent RA-RC	RA-RC				
Yale E1R	YA8				
Yale GA	GA				
Falcon E-R	FAL				
Kwikset	KW				

Keying

DESCRIPTION	PDQ KEYING DESIGNATOR
Keyed Different (Default)	KD
Keyed Alike	KA
1 Bitted	KO
Master Keyed	MK
Construction Master Keyed	CMK
Grand Master Keyed	GMK

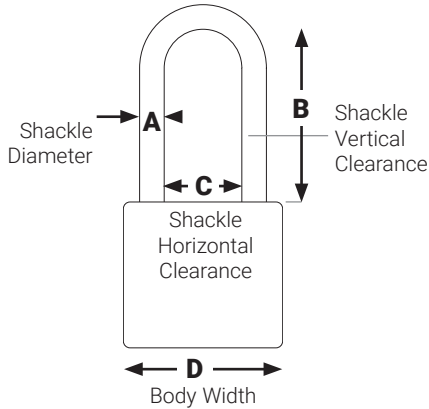

Shackle Dimensions

PL-1 SFIC Padlock

Solid brass padlock with hardened steel shackle, accepts standard 6 or 7 pin SFIC lock cylinders (sold separately).

Typical Applications

- Gates
- Higher Education
- Industrial
- K-12 Education



Shackle Size

A DIAMETER	B VERTICAL CLEARANCE	C HORIZONTAL CLEARANCE	D BODY WIDTH
5/16"	1-1/8"	25/32"	1-3/4"

EPIC Series

European Profile Interchangeable Core

Features

- PDQ EPIC Series cylinders include a special format interchangeable core to retrofit into standard European Profile applications.
- Solid brass construction
- Can be incorporated into existing master key system
- Large thumbturn for ease of use
- EPIC Cores receive special machining to interface with housing. Specify (EP) designator for these cores (example: I5207EP-A)

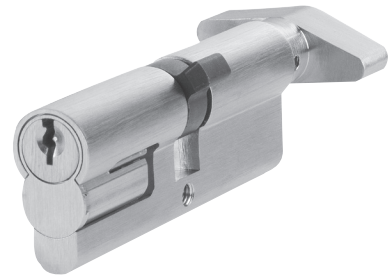

Security. Performance. Flexibility.

Exit devices are a critical part of a building's fire and life safety egress system. PDQ manufactures a full line of exit devices, including rim, vertical rod and mortise for both wide and narrow stile doors. These devices provide the best combination of simplicity, strength, durability, aesthetics, and innovation and are perfect for a vast array of applications.

Comprehensive Offering

6300 Architectural Wide Stile



Applications

The all NEW 6300 Series Wide Stile Exit Devices incorporate modern push bar styling for heavy traffic applications. These Grade 1 certified devices are put to the ultimate test everyday in K-12, higher education, Healthcare, and government buildings. Other applications include offices, banks, assisted living facilities, retail stores, and other commercial buildings that have constant traffic.

6400 Architectural Narrow Stile



Applications

The all NEW 6400 Series Narrow Stile Exit Devices incorporate modern push bar styling for heavy traffic applications. These Grade 1 certified devices are put to the ultimate test everyday in K-12, higher education, Healthcare, and government buildings. Other applications include offices, banks, assisted living facilities, retail stores, and other commercial buildings that have constant traffic.

4200 Commercial Wide Stile



Applications

When low cost and dependability are essential, the 4200 Series is a great choice. A reliable workhorse, the 4200 Series is an economical answer for stock doors and frames.

9300 Mullions

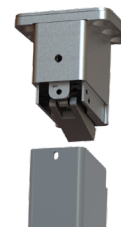

Applications

Designed for quick removal, the 9300 mullion is ideal in situations where carts, gurneys and large machinery need to pass freely through an opening. Popular applications include Healthcare, industrial manufacturing, and commercial businesses.

Introducing the 6300/6400 SERIES Architectural Exit Device



Highlights

Chassis support is cast for high strength.

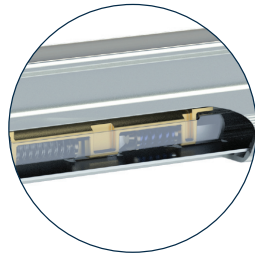
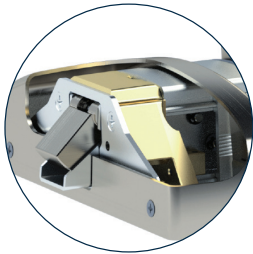

Push bar has angled ends and is nearly flush when dogged.

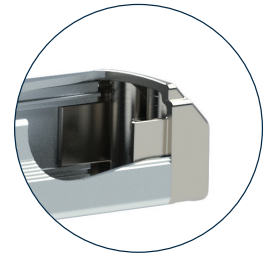
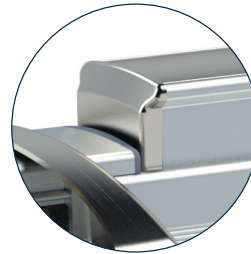

Flush end cap is standard, heavy duty engineered casting keys into the rail for ultimate pry resistance.



Cush spring quiets device in both directions. Compression spring returns the touch bar providing more reliability than a torsion type spring.

Features

- Rugged, reliable, flexible, and simple design
- Designed & Assembled in Lancaster, PA
- Patent Pending
- Quiet operation - large heavy-duty spring cushion quiets both the compression/extension of the push bar
- Internal compression spring ensures long lasting push bar return
- Engineered strong and overbuilt for the most demanding environments
- Durable, heavy-duty flush end cap is standard and resist prying
- Stands up to cart abuse, heavy-duty flush end cap and tapered push bar designed to deflect hits and minimize damage
- Simple field door prep and installation
- Dogging holds bar in a retracted position nearly flush with head cover and rail
- Hex Key provided to dog/release the device
- No exposed screws on back of bar
- True 2-3/4" backset (with 5/8" frame stop and 1/8" door gap)
- Wood and machine screws included with each device
- Devices and trim are non-handed
- Ten (10) year warranty



Rim
6300R / 6400R



Surface Vertical Rod
6300V / 6400V



Concealed Vertical Rod
6300C / 6400C



Mortise
6300M

6300/ 6400R Series

Wide/Narrow Stile Rim Exit Device

6300R Wide Stile/6400R Narrow Stile

Panic & Fire Rated



Specifications

Rail	• Extruded aluminum • Specify 630F for full stainless surfaces (roll formed)
Latch	• Stainless steel dead locking with 3/4" throw
Hand	• Device is non-handed • Trim is non-handed or field reversible
Dogging	• Hex key dogging standard • Cylinder dogging optional • Dogging not available for fire labeled devices
Minimum Stile Width	• 6300 - 3-1/2" • 6400 - 2-1/8"
Door Thickness	• 1-3/4" - 2" (Consult factory for other)
Door Width	• 24", 36", 48" standard
Door Height	• Panic - Up to 10' • Fire - See fire ratings charts page 26
Strike Options	• Default roller • Blade stop • Double door • Windstorm/Fire Mullion - Panic Mullion uses standard roller strike
Finishes	• 605 - Polished Brass, 606 - Satin Brass, 613E - Dark Bronze, 622 - Flat Black, 626 - Satin Chrome, 630 - Satin Stainless Steel, 630F - Full Stainless Steel • Optional Anti Microbial Coating available on 626 and 630
Fasteners	• Includes machine and wood screws • SNB Optional
Warranty	• Ten (10) year limited warranty
Electrified Options	• Motorized Latch Retraction • Request to Exit/Signal Switch • Alarmed Exit • Latch Bolt Monitor • ISMC Connectors • Delayed Egress
Certifications: Compliances: Listings:	• Listed for UL 305 "Panic", listed for UL 10C "Fire Exit Hardware" up to 3 hours. • Certified to ANSI/BHMA A156.3 Grade 1 • FL #40297 +60/-65 psf 4080 16ga Single • FL #+50/-50 psf 4080 18ga Single • Complies with ADA (Americans with Disabilities Act) and ICC/ANSI 117.1 for Accessible and Usable Buildings • Meets requirements of the BAA as a COTS product manufactured in the United States

6300/ 6400V Series

Wide/Narrow Stile Surface Vertical Rod Exit Device

6300V Wide Stile/6400V Narrow Stile Panic & Fire Rated



Specifications

Rail	• Extruded aluminum • Specify 630F for full stainless surfaces (roll formed)
Latch	• Top - Stainless Steel 3/4" toggle • Bottom - 5/8" Travel Drop Bolt • Less bottom rod option
Hand	• Device is non-handed • Trim is non-handed or field reversible
Dogging	• Hex key dogging standard • Cylinder dogging optional • Dogging not available for fire labeled devices
Minimum Stile Width	• 6300 - 3-1/2" • 6400 - 2-1/8"
Door Thickness	• 1-3/4" - 2" (Consult factory for other)
Door Width	• 24", 36", 48" standard
Door Height	• Panic - Up to 10' • Fire - See fire ratings charts page 26
Strike	• Cast top strike, plate bottom strike
Finishes	• 605 - Polished Brass, 606 - Satin Brass, 613E - Dark Bronze, 622 - Flat Black, 626 - Satin Chrome, 630 - Satin Stainless Steel, 630F - Full Stainless Steel • Optional Anti-Microbial Coating available on 626 and 630
Fasteners	• Includes machine screws and wood screws • SNB Optional
Warranty	• Ten (10) year limited warranty
Electrified Options	• Motorized Latch Retraction • Request to Exit/Signal Switch • Alarmed Exit • Latch Bolt Monitor • ISMC Connectors
Certifications: Compliances: Listings:	• Listed for UL 305 "Panic", listed for UL 10C "Fire Exit Hardware" up to 3 hours. • ANSI/BHMA A156.3 Grade 1 • Complies with ADA (Americans with Disabilities Act) and ICC/ANSI 117.1 for Accessible and Usable Buildings • FL # +50/-50 psf 8080 18ga Pair • Meets requirements of the BAA as a COTS product manufactured in the United States

6300/ 6400C Series

Wide/Narrow Stile Concealed Vertical Rod Exit Device

6300C Wide Stile/6400C Narrow Stile Panic & Fire Rated



Specifications

Rail	• Extruded aluminum • Specify 630F for full stainless surfaces (roll formed)
Latch	• Top - Stainless Steel 3/4" toggle • Bottom - 5/8" Travel Drop Bolt • Less bottom rod option
Hand	• Device is non-handed • Trim is non-handed or field reversible
Dogging	• Hex key dogging standard • Cylinder dogging optional • Dogging not available for fire labeled devices
Minimum Stile Width	• 6300 - 3-1/2" • 6400 - 2-1/8"
Door Thickness	• 1-3/4" - 2" (Consult factory for other)
Door Width	• 24", 36", 48" standard
Door Height	• Panic - Up to 10' • Fire - See fire ratings charts page 26
Strike	• Cast top strike, plated bottom strike
Finishes	• 605 - Polished Brass, 606 - Satin Brass, 613E - Dark Bronze, 622 - Flat Black, 626 - Satin Chrome, 630 - Satin Stainless Steel, 630F - Full Stainless Steel • Optional Anti-Microbial Coating available on 626 and 630
Fasteners	• Includes machine and wood screws • SNB Optional
Warranty	• Ten (10) year limited warranty
Electrified Options	• Motorized Latch Retraction • Request to Exit/Signal Switch • Alarmed Exit • Latch Bolt Monitor • ISMC Connectors • Delayed Egress
Certifications: Compliances: Listings:	• Listed for UL 305 "Panic", listed for UL 10C "Fire Exit Hardware" up to 3 hours. • ANSI/BHMA A156.3 Grade 1 Pending • Complies with ADA (Americans with Disabilities Act) and ICC/ANSI 117.1 for Accessible and Usable Buildings • Meets requirements of the BAA as a COTS product manufactured in the United States

6300M Series

Mortise Exit Device

6300M Wide Stile Panic & Fire Rated



TLA Head Cover
Optional head cover
*630 Finish only



Specifications

Rail	• Extruded aluminum • Specify 630F for full stainless surfaces (roll formed)
Latch	• Stainless steel dead locking with 3/4" throw
Hand	• Field reversible
Dogging	• Hex key dogging standard • Cylinder dogging optional • Dogging not available for fire labeled devices
Minimum Stile Width	• 5"
Door Thickness	• 1-3/4" - 2" (Consult factory for other)
Door Width	• 24", 36", 48" standard
Door Height	• Panic - Up to 10' • Fire - See fire ratings charts page 26
Strike Options	• Default ASA (4-7/8")
Finishes	• 605 - Polished Brass, 606 - Satin Brass, 613 - Oil Rubbed Bronze, 622 - Flat Black, 626 - Satin Chrome, 630 - Satin Stainless Steel, 630F - Full Stainless Steel • Optional Anti Microbial Coating available on 626 and 630
Fasteners	• Includes machine screws and wood screws • SNB Optional
Warranty	• Ten (10) year limited warranty
Electrified Options	• Motorized Latch Retraction • Request to Exit/Signal Switch • Alarmed Exit • Latch Bolt Monitor • ISMC Connectors • Delayed Egress
Certifications: Compliances: Listings:	• Listed for UL 305 "Panic", listed for UL 10C "Fire Exit Hardware" up to 90 minutes. • Complies with ADA (Americans with Disabilities Act) and ICC/ANSI 117.1 for Accessible and Usable Buildings • Meets requirements of the BAA as a COTS product manufactured in the United States

6300D Series

Dummy Exit Device

6300D Dummy

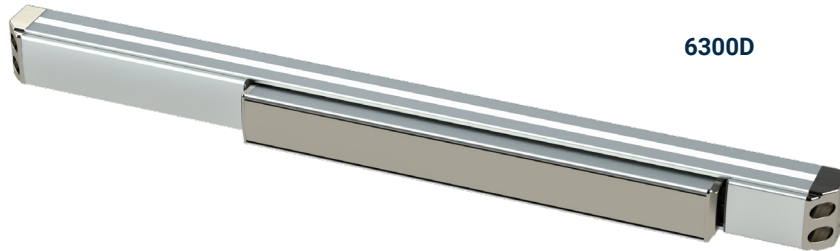

Specifications

Rail	• Extruded aluminum
Hand	• Device is non-handed
Dogging	• Dogging standard • Active push bar, dog to make inactive
Minimum Stile Width	• 6300 - 3-1/2"
Door Thickness	• 1-3/4" - 2" (Consult factory for other)
Door Width	• 24", 36", 48" standard
Finishes	• 605 - Polished Brass, 606 - Satin Brass, 613 - Dark Bronze, 622 - Flat Black, 626 - Satin Chrome, 630 - Satin Stainless Steel, 630F - Full Stainless Steel • Optional Anti Microbial Coating available on 626 and 630
Fasteners	• Includes machine and wood screws • SNB Optional
Warranty	• Ten (10) year limited warranty
Electrified Options	• Request to Exit/Signal Switch • ISMC Connectors
Certifications: Compliances: Listings:	• Complies with ADA (Americans with Disabilities Act) and ICC/ANSI 117.1 for Accessible and Usable Buildings • Meets requirements of the BAA as a COTS product manufactured in the United States

6300/6400 Series

Wide Stile/Narrow Stile Exit Device Trims

Trims are non-handed and use simple door prep based on a 2 hole bolt pattern with 7" centers, or a 4 hole bolt pattern with 7"x1-3/8" centers.

Narrow escutcheons work with both wide and narrow stile devices. Wide escutcheons work only with wide stile devices.



6N Narrow Escutcheon - A narrow profile escutcheon for 6300 or 6400 device. Available in 6 lever styles, and in 6 functions. Use with narrow stile devices or a wide stile device when a slimmer look is desired.



6W Wide Escutcheon - A wide escutcheon for the 6300 device. Available in 6 lever styles, and 5 functions - including electric locking. Use with wide stile devices, when a more substantial look is desired, or for retrofit where covering existing holes is important.

**Not compatible with 6400 narrow stile devices*



6T Thumb Latch - A grip pull with a thumb latch for 6300 or 6400 devices. Available in 3 functions.

**Not compatible with 6400C narrow stile devices.*



6P Pull Plate - Stainless Steel pull plate for 6300 device.

**Not compatible with 6400 narrow stile devices.*



6G Grip Pull - A grip pull for 6300 or 6400 devices. Made of stainless steel, this grip pull is available in 2 functions.



6S Rose Trim - Rose trim that fits into standard 161 prepped door with thru bolts. Works with 6300 rim, SVR and CVR devices. Available in 3 lever styles and in 4 functions.

**Not compatible with 6400 narrow stile devices*

Lever Styles

PHL



BSN



MIA



ORL



CHI



LAX



9300 SERIES

Mullions

9300 Mullion

The PDQ 9300 Series removable mullions are designed for use with the 6300/6400 Series Rim Exit Devices on pairs of doors. They are designed for quick removal from the top bracket by simple operation of the rim cylinder when a clear, unobstructed large opening is required. Once the mullion is removed, carts, gurneys, large machinery and the like can freely pass through the opening. When the mullion is re-installed, the unit will self lock in place without a key.

Specifications

Mullion Head/Foot brackets:	• Cast Stainless Steel
Tube Dimensions:	• Powder Coated 2" x 3" Steel - 3/16" Wall
Strike:	• 639080 Strike included for Fire Labeled • Strike not included for panic mullion. Use supplied strike with exit device.
Size:	• 8' or 10' lengths - Can easily be cut to shorter size in field
Finish:	• Powder Coated 689 (Aluminum) - can be painted
Electrified Options:	• Wire routing w/ plugs
Warranty:	• One (1) year limited warranty
Certifications: Compliances: Listings:	• Fire model is 3 hour fire labeled for pairs up to and including 8' x 8' (With 6300RF/6400RF Rim Device) • Meets requirements of the BAA as a COTS product manufactured in the United States

Orientation

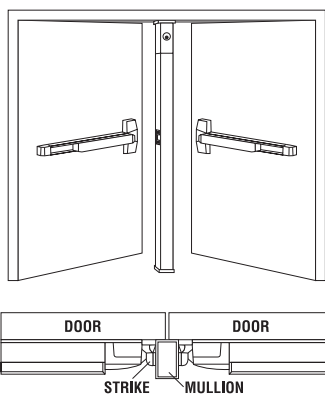

Key Removable

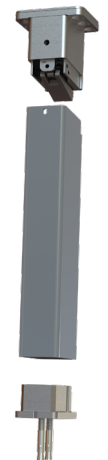

Hex Key Removable

MLR - Motorized Latch Retraction

Operation

When power is applied the MLR retracts the latch(es) allowing the door to be opened. Duration of latch retraction is controlled by the access control system. Power can be continuously applied to electronically dog the exit device.

Features

- Works with 6300 wide stile or 6400 narrow stile devices; panic or fire labeled
- Innovative motor drive retracts push pad
- Allows free egress at all times
- Suitable for pairing with Low Energy Power Operators

Electrical Specifications

- Input voltage 24 VDC \pm 10%
- Non-polarized power leads
- Latch Retraction Speed: \sim 300mS
- Average in-rush current: 900mA
- Average holding current: 200mA

Retrofit kit part number: 639026

- Designed to field retrofit 6300 or 6400 series devices
- Includes motor drive module, connectors and fasteners

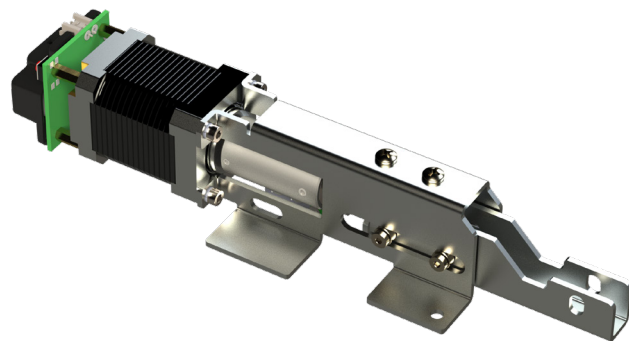

6W 99 - Electrified Locking/Unlocking Trim

For ordering information see trim section



Operation

Field selectable operation - Fail Safe (Unlocked when power removed) or Fail Secure (Locked when power removed). Key allows entry but does not change state of lock.

Features

- Motorized locking/unlocking
- Field changeable from Fail Secure (Default) to Fail Safe
- AC or DC input voltage.
- Works with rim, surface vertical rod and concealed vertical rod devices.
- Two (2) year warranty
- Designed and assembled in the USA, Lancaster, PA.

Electrical Specifications

- Non-polarized power leads
- Power requirements: 12-24VDC/VAC \pm 10%
- Average in-rush current: 12-24VDC/VAC: 1A for 1 second
- Average holding current: 12-24VDC: 5mA after 30 seconds
12-24VAC: 15mA after 30 seconds
- Power must be applied for a minimum of 5 seconds

DELAYED EGRESS

Electrified Options and Accessories



DE - Delayed Egress

Overview:

This Delayed Egress exit device is designed to slow the egress or exit from a particular area, usually for security reasons or to prevent unauthorized access.

Delayed egress exit devices are commonly used where enhanced security measures are needed. Examples include hospitals, schools, airports, or shopping centers. These devices are designed to meet safety regulations and building codes. Local regulations and building codes may govern the specific requirements for the installation and usage of these devices.

Device Function Overview:

- Armed: When armed, this device activates an internal blocking mechanism to prevent exiting the door from the inside until the proper release sequence has been completed.
- Release Delay: When an attempt is made to open the door from the inside, the device sounds an alarm and initiates a countdown.
- Free Exit: Upon completion of the Release Delay countdown, the device will release the push bar and allow free exit from the door until it is reset. An alarm will continue to sound until the device is reset.
- Fire Contacts: The power supply for this device must be connected to a fire alarm to cut power to the device, allowing immediate egress in the event of an emergency

IMPORTANT

Local regulations and building codes may dictate specific requirements for the installation and usage of these devices.

Electrical Specifications:

24VDC +/-10%, 1A average inrush, 250mA continuous

DELAYED EGRESS

Electrified Options and Accessories

DEFINITIONS

Fire Alarm – Power Supply

Usage: Required by Code

Power supply must be wired to cut power to the DE device on activation of fire alarm. The example wiring diagram in the manual shows how device should be wired if using our PS220 power supply. A UL 294 rated power supply providing a minimum of 1 Amp at 24VDC (+/-10%) with fire alarm link is required.

Inhibit Contact

Usage: Optional

Type: Normally Open

Contact closure allows free egress/ingress without sounding the alarm. After Inhibit completes, the system resets automatically when contact position conditions are satisfied (door position switch and optional latch monitor switch). Inhibit is usually wired to an access control system to allow entry from the outside or exit from the inside without alarming the device. When not used for Inhibit, this input can be used to reset a device in alarm.

Door Position Switch (DPS)

Usage: Preferred

Type: Normally Closed

The Door Position Switch input senses door opening. If the door has been opened without using the Inhibit feature, the internal alarm will sound. The DPS contact must be closed to arm the device including after inhibit has been used. If not used, bypass DPS by closing circuit.

Relay Contacts

Usage: Optional

Type: SPDT

Opens or closes contact upon system arming. Can be used to signal security system when device is armed. Relay contacts will change state when device alarms and during Inhibit.

Nuisance Delay

Configurable: Immediate, 1 second

The Nuisance Delay starts from the first moment the push bar is pressed. If set to Immediate, the device will immediately begin the Release Delay. If set to 1 second, the device will sound a beep when pressed. If the device is released before 1 second it will return to the previous, armed state. If held for longer than 1 second the device will proceed to the Release Delay. This is useful in public areas where the device may be accidentally activated.

Release Delay

Configurable: 15 seconds, 30 seconds

When the Release Delay is initiated, the push bar will remain locked and a warning beep will sound for the configured number of seconds (less any time already occupied by the Nuisance Delay). Once started, the Release Delay sequence cannot be stopped and the device will allow egress after the configured time has passed.

Rearm Delay

Configurable: Immediate, 1 second, 5 seconds, 15 seconds

The time the device waits to arm following arming with the Key Switch or Inhibit Input. The device will arm when door closes (and DPS is satisfied) and the rearm delay has completed. Rearm delay can also be set to 15 seconds to allow door to close after Inhibit when DPS is not used.

INTERFACE

Key Switch

- The Key Switch Arms or Disarms the device.
- Turning the Key Switch counter-clockwise arms the device (following the Rearm Delay)
- Turning the Key Switch clockwise Disarms the device immediately

Status Indicator LED

- Armed – Solid Red LED
- Disarmed / Alarmed – Red LED is off
- Inhibit Active – Red LED is off

Internal Alarm

- Nuisance Delay Active – Short continuous beep
- Release Delay Initiated – Long continuous beep
- Alarming – Pulsing Beep

6300/6400 Series

Electrified Options and Accessories

AL - Alarm Kit ALHW - Alarm Kit (Hardwire power & relay output)

Operation

Battery powered self-contained alarm kit for 6300 or 6400 exit device.

The alarm kit is armed via clockwise rotation of the key. If armed, a siren sounds, and the red LED rapidly flashes when the touch bar is depressed. Factory default is continuous alarm. Rotate key counterclockwise to silence siren and disarm the unit.

Alarm kit for panic devices include a third position for dogging the device.

Alarm Mode: Unit can be configured to auto silence the alarm after 7, 3 or 1 minute.

Armed State: Red LED blinks every 10-seconds to indicate unit is armed.

Armed State: Red LED blinks every 10-seconds to indicate unit is armed.

Low Battery: Siren will intermittently chirp when battery is low (<7VDC). Siren chirps regardless of arming state.

Battery Life: 1-year life expectancy in armed, unactuated state.

Siren Intensity: 95dB @ 4in

Operating Temperature: 0 C – 49 C

Max Relative Humidity: 85% (non-condensing)

Included Decal: "EMERGENCY EXIT ONLY – ALARM WILL SOUND"

Latchbolt Monitor: Standard for SVR device

Optional Rim Latchbolt Monitor: Adds latchbolt monitor. When armed, either the touch bar or latchbolt monitor actuate siren.

Optional Relay Output: Adds a Single Pole Double Throw (SPDT) relay and hardwire power input to the unit. When armed, relay state changes when the touch bar is depressed. Can be used with access control systems. Dry contact SPDT rated 125VAC/ 60VDC with 9VDC coil



Bar Length:

36" Device – 2" max cut

48" Device – 8" max cut

Electrical Specifications:

Power Requirements: One 9-VDC Alkaline Battery (included).

Optional (with relay output): 12-24VDC/VAC

±10% hardwired power. Battery can be used as emergency backup. It is protected from hardwired power.

Power Consumption:

Typical: 18µA

During alarming: 18mA

How to order: Specify AL for alarm kit or ALHW alarm kit with optional hardwire and relay output.

Panic rated device -

Position 1: On/Armed

Position 2: Off

Position 3: Off & Dogged

Fire Rated Device -

Position 1: On/Armed

Position 2: Off

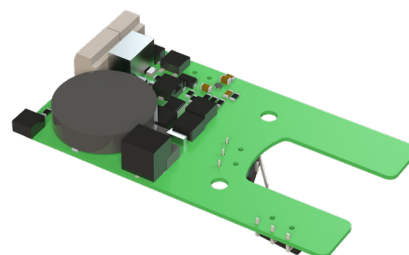

6300/6400 Series

Electrified Options and Accessories

SS - Signal Switch/REX - Request to exit

Operation:

Monitors push bar operation. NO or NC operation.

Electrical Specifications:

Single Pull Double Throw (SPDT): 125VAC – 3A
30VDC – 3A

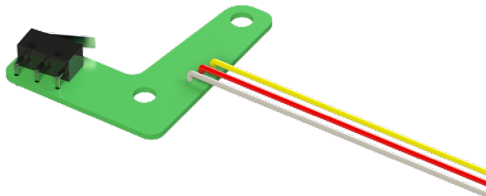

LM - Latch bolt Monitor Switch

Operation:

Monitors latch status. Available on Rim, SVR, CVR and Mortise. NO or NC operation.

Electrical Specifications:

Single Pull Double Throw (SPDT): 125VAC – 3A
30VDC – 3A

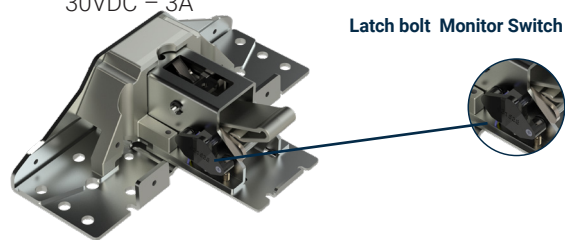

Latch bolt Monitor Switch

ISMC - Industry Standard Molex Connector

Operation:

Molex type connectors for simpler wiring

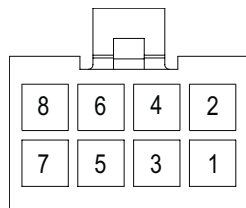

Terminal insertion end shown for ISMC connector (PDQ P/N 88850)

Function	Wire Color	Optional ISMC Pin#
Power*	White/Blue	1
Power*	White/Blue	2
REX(COM)	Yellow	3
REX(N/O)	Red	4
REX(N/C)	Gray	5
LM(COM)	Black	6
LM(N/O)	Brown	7
LM(N/C)	Blue	8

*Power wires are non-polar

Wire Routing Kit

Included with Latch bolt Monitor Switch, 6W99 Trim, and available as a kit.

Description: Safely route wires through device where they will not be pinched.

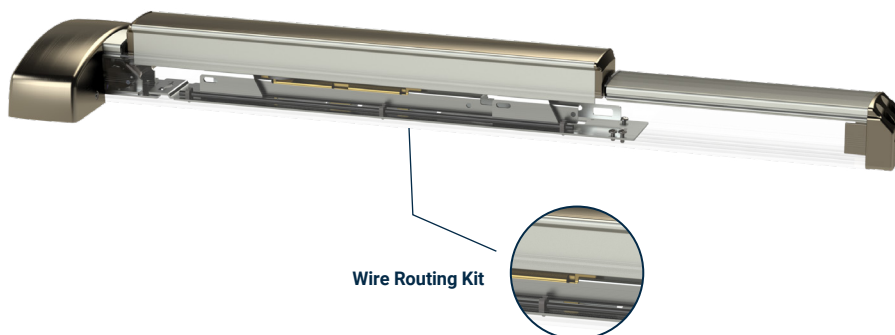

Wire Routing Kit

4200 Series

Commercial Stile Exit Device

Economical, Reliable Workhorse

- Rim, Surface Vertical Rod
- Compatible with 161 door prep
- Architectural plated finishes available
- 5-Year Warranty



RIM
ANSI TYPE 1

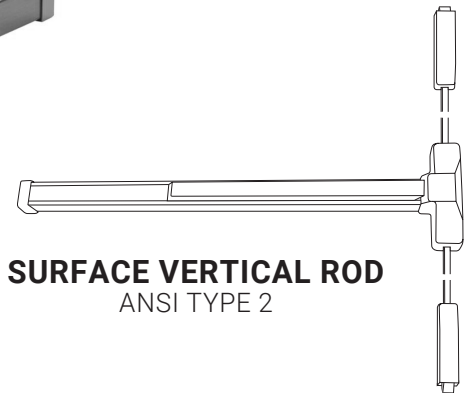

SURFACE VERTICAL ROD
ANSI TYPE 2



ADA COMPLIANT

Specifications (For all models Unless Noted*)

CHASSIS:	• Corrosion resistant plated steel
RAIL:	• Heavy gauge steel or stainless steel
LATCH:	• RIM (R) – 3/4" throw*
BACKSET:	• 2-3/4" Backset Compatible with 161 prep
HAND:	• Device is non-handed
DOGGING:	• Hex key dogging standard • Dogging not available on fire listed devices
MINIMUM STILE WIDTH:	• 4-1/4" for device (exit only) • Minimum stile requirements with trim varies by trim type
DOOR THICKNESS:	• 1-3/4" standard
DOOR WIDTH:	• Standard for 3 ft doors, option available for doors up to 4'
FINISHES:	• 605 – Polished Brass, 626 – Satin Chrome, 630 – Satin Stainless Steel, 689 – Aluminum, 695 - Duro Bronze, 696 – Gold
FASTENERS:	• Includes machine screws and wood screws • Sex nuts supplied with all Fire Listed devices
WARRANTY:	• Five (5) year limited warranty
CERTIFICATIONS, LISTINGS, COMPLIANCES:	• UL 305 listed for "Panic", UL listed for "Fire Exit Hardware" labeled for up to 1-1/2 hours, 3'0" x 7'0" Max Size • Complies with ADA (Americans with Disabilities Act) and ICC/ANSI 117.1 for Accessible and Usable Buildings • TAA compliant. Country of origin: Taiwan

Surface Vertical Rod Exceptions*

LATCH:	• SURFACE VERTICAL ROD (V) – Top Latch-Pullman with dead latching 5/8" throw - Bottom Latch- Pullman with 5/8" throw, held retracted during door swing
VERTICAL RODS:	• Stock for 7' doors standard. Extension rods available for doors up to 10'.

Architectural Finishes. No Plastic Parts.

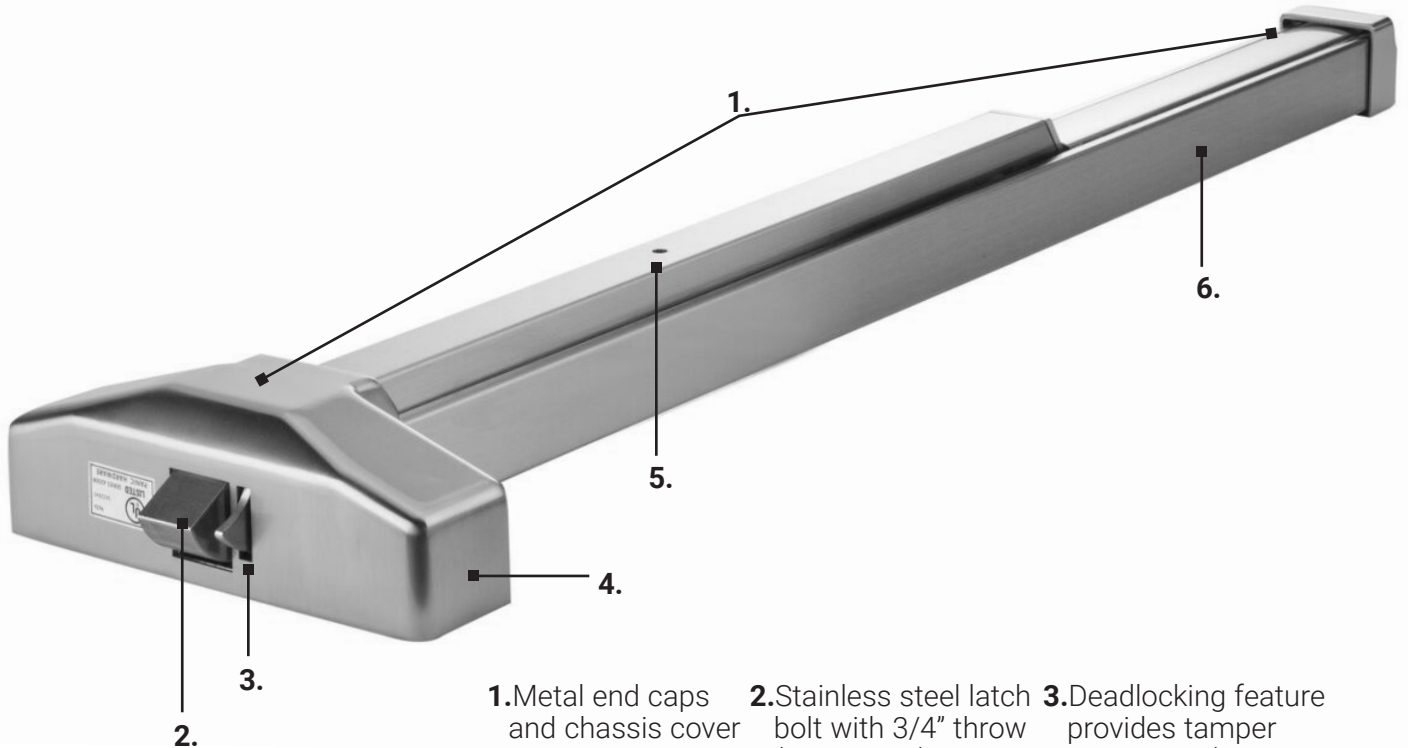

- 1. Metal end caps and chassis cover
- 2. Stainless steel latch bolt with 3/4" throw (rim shown), 5/8" throw (vertical rod devices)
- 3. Deadlocking feature provides tamper resistance (rim shown)
- 4. Corrosion resistant steel plated chassis
- 5. Hex key dogging (Dogging not available with fire labeled devices)
- 6. Heavy gauge roll formed steel or stainless steel rail

Decorative Finish Collection

Architectural

605 Bright Brass, Clear Coated
626 Satin Chromium Plated
630 Satin Stainless Steel

Painted

689 Aluminum
695 Dark Bronze
696 Gold



4200 Series

Configurations/Trim and Levers

Levers*



Philadelphia



Boston



Miami

Trims*



Escutcheon



Sectional



Grip Pull



Pull



Plate



Sectional Knob

Architectural Finishes*



605 (US3)
Bright Brass



613E
Oil Rubbed
Bronze



626 (US26D)
Satin Chromium



630 (US32D)
Satin Stainless
Steel

Painted Finishes*



689 (US28)
Aluminum



695
Dark Duranodic
Bronze

*Contact factory or consult PDQ Price Book to check availability of lever/trim combinations and/or finishes for specific products.

GRADE 1

Making Door Control Easy

PDQ offers a comprehensive line of door closers designed and manufactured to ensure superior performance and reliability. They offer the perfect combination of reliability, appearance, and durability. With a wide range of models and features, PDQ has a door closer for most applications.

7100 Institutional



7100 — The 7100 Series is PDQ's top of line heavy duty closer. It is designed for high use, high abuse institutional applications such as K-12, higher education and government buildings. 7100 Series closers are ideal for retrofit and new construction applications where strength and durability are required.

5500 Institutional



5500 (Full cover) — Designed for maximum versatility, the 5500 Series sports a full cover and can be used for both commercial and institutional applications. This rugged workhorse is perfect for high traffic applications including federal/state buildings, assisted living facilities, hospitality, retail, religious, and medical buildings for example.

5300 Commercial



5300 (Slim cover) — The aesthetically pleasing 5300 Series comes standard with a slim line cover and offers the ideal combination of appearance, reliability, and durability for today's market. This rugged closer is perfect for high traffic applications such as healthcare, hospitality, government, assisted living, retail, and religious facilities.

5100 Commercial



5100 — 5100 Series Door Closer is a heavy duty multi-feature closer that is perfect for high use, high abuse applications such as K-12, higher education, and government buildings. The 5100's compact design is ideal for interior door applications where it's distinctive lines harmonize with most decors.

3100 Light Commercial



3100 — Designed for medium-light duty applications, the 3100 Series is ideal for aluminum storefronts, interior offices, multi family, hospitality and many other applications. The 3100 combines dependable operation, low maintenance and stylish look.

7100 SERIES

Institutional Full Featured Heavy Duty Closer

GRADE 1

Top Choice for High Use / Abuse Applications

- Instructions include full-size, tape-on application specific templates
- Great for retrofits. Mounting hole pattern matches LCN® 4040
- Meets Barrier Free/ADA Requirements

Features

- Heavy duty, fully featured architectural style door control
- High strength cast iron body and forged steel arm assembly provide maximum durability and reliability in the most brutal environments
- Backcheck positioning valve feature provides a consistent backcheck snubbing range for regular, top jamb and parallel arm applications, preventing costly damage during forceful opening of the door
- The 7100 series has a fully adjustable spring range that can be set to meet barrier free requirements
- Maximum 3" reveal for Top Jamb.

Typical Applications

- Assisted Living
- Higher Education
- High Use/High Abuse Situations
- K-12 Education
- Military and Government
- Multi-family
- Offices
- Public Buildings



Specifications

BODY:	• High Strength Cast Iron
ARMS:	• Forged steel main arm
ARM OPTIONS:	<ul style="list-style-type: none"> • PA – Parallel Arm • HO – Hold Open • DS/DSHO – Heavy Duty Parallel Stop • RA – Regular Arm • SCS/SCSHO – Spring Cushion Stop for DS/DSHO • TA/TAHO – Track Arm • EDA/EDAHO – Extra Duty Parallel Arm
PISTON:	• 1-1/2" diameter
ADJUSTMENT:	<ul style="list-style-type: none"> • Hydraulic controlled closing • Hydraulic backcheck standard • Backcheck positioning valve standard (starts backcheck snubbing sooner) • Optional delayed action (in addition to backcheck)
ADJUSTMENT VALVES:	• All Adjustment Valves are STAKED to prevent removal during adjustment.
SIZE:	• Adjustable BF through 6
MOUNTING RETROFIT:	<ul style="list-style-type: none"> • Mounting hole pattern retrofits LCN® 4040 • Tri-packed for regular, top jamb and parallel arm installations • Includes sex nuts/bolts and screws for wood/metal doors/frames • Self drilling self tapping screws standard • Separate limiting stop may be required for high abuse applications
COVER:	• Full plastic cover standard, optional full metal cover available
COLOR & ARCHITECTURAL FINISHES:	• 605 – Polished Brass, 625 – Polished Chrome, 689 – Aluminum, 693 – Black, 695 – Duro Bronze, 696 – Gold
WARRANTY:	• Twenty-five (25) year Limited Warranty
CERTIFICATIONS, LISTINGS, COMPLIANCES:	<ul style="list-style-type: none"> • UL listed for labeled swinging fire doors rated up to and including 3 hours • Certified to ANSI/BHMA A156.4 Grade 1 • Complies with ADA (Americans with Disabilities Act) and ICC/ANSI 117.1 for Accessible and Usable Buildings • TAA compliant. Country of origin: KR

5300 Slim Cover 5500 Full Cover SERIES

Commercial Full Featured Closer

GRADE 1

Biggest Bang For Your Buck

- Perfect for stocking distributors; tri-packed, size range 1 through 6
- Great for retrofits. Mounting hole pattern matches Norton 8300/8500 and Yale 3300/3500
- 25-Year Warranty

Features

- 1-1/4" diameter hardened steel piston
- Heavy duty, fully featured architectural style door control
- Available with modern streamline cover or full sized cover
- Compact appearance and features meet the demands of institutional and commercial applications
- The standard tri-pack, full range spring adjustment and common 12" x 3/4" mounting hole pattern make the 5300/5500 ideally suited for stocking distributors and retrofit applications
- Adjustable hydraulic backcheck prevents damage for uncontrolled door opening
- Perfect solution for a variety of applications requiring streamline architectural grade door controls
- Maximum 4" reveal for Top Jamb.

Typical Applications

- Assisted Living
- Exterior Doors in Heavy Draft/Wind Conditions
- Government Facilities
- Healthcare
- Higher Education
- Hospitality
- Houses of Worship
- Industrial
- K-12 Education
- Offices
- Retail



5300 Series



5500 Series

Specifications



BODY:	• Cast High Strength Aluminum Alloy Body	
ARM OPTIONS:	<ul style="list-style-type: none"> • PA – Parallel Arm • HO – Hold Open • DS/DSHO – Heavy Duty Parallel Arm Stop • RA – Regular Arm 	<ul style="list-style-type: none"> • SCS/SCSHO – Heavy Duty Parallel Arm Cushion Stop • TA/TAHO – Track Arm • EDA/EDAHO – Extra Duty Parallel Arm • PS – Pivot Stop Arm*
ADJUSTMENT:	<ul style="list-style-type: none"> • Hydraulic controlled closing • Separate hydraulic backcheck standard • Optional adjustable delayed action (in addition to backcheck) 	
RETROFIT:	• Common 12" x 3/4" mounting hole pattern retrofits Norton 8300/8500® and Yale 3300/3500	
SIZE:	• Adjustable  BF through 6	
MOUNTING:	<ul style="list-style-type: none"> • Includes sex nuts/bolts and screws for wood/metal doors/frames • Tri-packed for regular, top jamb and parallel arm installations • Separate limiting stop may be required for high abuse applications • Self drilling, self tapping screws standard 	
COVER:	• 5300 Series - Streamline plastic cover (non-handed) 5500 Series - Full plastic cover standard (field reversible)	
COLOR & ARCHITECTURAL FINISHES:	• 605 – Polished Brass, 625 – Polished Chrome, 689 – Aluminum, 693 – Black, 695 – Duro Bronze, 696 – Gold	
WARRANTY:	• Twenty-five (25) year Limited Warranty	
CERTIFICATIONS, LISTINGS, COMPLIANCES:	<ul style="list-style-type: none"> • UL listed for labeled swinging fire doors rated up to and including 3 hours • Certified to ANSI/BHMA A156.4 Grade 1 • Complies with ADA (Americans with Disabilities Act) and ICC/ANSI 117.1 for Accessible and Usable Buildings • TAA compliant. Country of origin: KR 	

5100 Series

Commercial Full Featured Closer

GRADE 1

1 - 1/2" Diameter Hardened Steel Piston

- Handsome and durable with a full cover
- Architectural and painted finishes
- 25-Year Warranty

Typical Applications

- Aluminum Storefronts
- Assisted Living
- Government Facilities
- Higher Education
- Hospitality
- Houses of Worship
- Interior Office Doors
- Multi-family
- Offices
- Retail

Features

- Features a 1-1/2" diameter hardened steel piston
- Fully featured architectural style door control
- Full cover and flat design arm assembly provide both durability and aesthetically pleasing appearance in commercial and institutional applications
- The closer is ideally suited for installation on wood or metal doors and frames.
- The units are non-handed and fully adjustable from size one through six for maximum flexibility.
- The standard tri-pack feature provides versatility to permit regular, top-jamb and parallel arm installations.
- A range of sprayed and architectural finishes are available to compliment any décor.
- Maximum 4" reveal for Top Jamb.



Specifications

BODY:	• High Strength Aluminum Alloy Body
ARM OPTIONS:	<ul style="list-style-type: none"> • PA – Parallel Arm • HO – Hold Open • DS/DSHO – Heavy Duty Parallel Arm Stop • RA – Regular Arm • SCS/SCSHO – Heavy Duty Parallel Arm Cushion Stop • TA/TAHO – Track Arm • EDA/EDAHO – Extra Duty Parallel Arm • PS – Pivot Stop Arm*
PISTON:	• Hardened steel, 1-1/2" diameter
ADJUSTMENT:	• Hydraulic controlled closing • Separate hydraulic backcheck standard • Optional delayed action (in addition to backcheck)
SIZE:	• Adjustable 1 through 6
MOUNTING:	<ul style="list-style-type: none"> • Tri-packed for regular, top jamb and parallel arm installations • Includes sex nuts/bolts and screws for wood/metal doors/frames • Self drilling, self tapping screws standard • Separate limiting stop may be required for high abuse application
COVER:	• Full plastic cover standard, optional full metal cover available
COLOR & ARCHITECTURAL FINISHES:	• 605 – Polished Brass, 625 – Polished Chrome, 689 – Aluminum, 693 – Black, 695 – Duro Bronze, 696 – Gold
WARRANTY:	• Twenty-five (25) year Limited Warranty
CERTIFICATIONS, LISTINGS, COMPLIANCES:	<ul style="list-style-type: none"> • UL listed for labeled swinging fire doors rated up to and including 3 hours • Certified to ANSI/BHMA A156.4 Grade 1 • TAA compliant. Country of origin: KR

3100 Series

Light Commercial Closer

GRADE 1

Economical. Reliable. 25-Year Warranty.

- Multi-function heavy duty parallel arm
- Excellent for aluminum storefront openings
- Great for retrofits. Mounting hole pattern matches Yale 50 and Norton 1600

Typical Applications

- Aluminum Storefronts
- Assisted Living
- Hospitality
- Interior Offices
- Multi-family

Features

- Traditional door style door control for use in commercial door applications
- Fasteners are provided to facilitate installation on wood, hollow metal and aluminum doors and frames
- The closers are non-handed and tri-packed for maximum versatility to permit regular, top-jamb and parallel arm installations
- The common 9-1/16" mounting hole pattern permits simple installation on new and retrofit applications.
- Maximum 3-11/16" reveal for Top Jamb.



DOOR SAVER ARM OPTION SHOWN

Specifications



BODY:	• High strength aluminum alloy
ARM OPTIONS:	<ul style="list-style-type: none"> • PA – Parallel Arm • PS – Pivot Stop Arm • HO – Hold Open • DS/DSHO – Heavy Duty Parallel Arm Stop • RA – Regular Arm • SCS/SCSHO – Heavy Duty Parallel Arm Cushion Stop
ADJUSTMENT:	<ul style="list-style-type: none"> • Separate hydraulic backcheck standard • Hydraulic controlled closing standard
SIZE:	<ul style="list-style-type: none"> • 3101 = Adjustable BF - 4 • 3100 = Adjustable 3 - 6
MOUNTING:	<ul style="list-style-type: none"> • Common 9-1/16" x 3/4" mounting hole pattern retrofits Yale® 50, Norton® 1600 • Tri-packed for regular, top jamb and parallel arm installations • Includes sex nuts/bolts and screws for wood, metal doors frames • Self drilling self tapping screws standard • Separate limiting stop may be required for high abuse applications
COVER:	• Streamline plastic cover optional
COLOR FINISHES:	• 689 – Aluminum, 693 – Black, 695 – Duro Bronze, 696 – Gold
WARRANTY:	• Twenty-five (25) year Limited Warranty
CERTIFICATIONS COMPLIANCES:	<ul style="list-style-type: none"> • UL listed for labeled swinging fire doors rated up to and including 3 hours • Certified to ANSI/BHMA A156.4 Grade 1 • Complies with ADA (Americans with Disabilities Act) and ICC/ANSI 117.1 for Accessible and Usable Buildings • TAA compliant. Country of origin: KR

Reduce Door Wear and Tear

- Unique self-aligning screws
- Manufactured from anti-corrosive stainless steel
- Two spring strengths. Specific designs for 3' and 4' door.



605 Bright Brass 613 Oil Rubbed Bronze 630 Satin Stainless Steel 693 Black

PDQ's SCS Series Spring Cushion Stop helps reduce wear and tear on the opening. As the door begins moving through backcheck to its maximum opening angle, the stop acts as a shock absorber, dampening the impact forces.

Features

- The unit is an **add-on kit** that can be included as an option on DS/DSHO arms.
- It also can be installed on existing DS/DSHO arm applications using the existing threaded hole for the bumper stop and one of the mounting screw holes.
- The spring cushion kit is available in two spring sizes, allowing it to be tailored to provide more effective cushioning for specific door widths
- Designed to be self aligning, the unit works with any door that incorporates a PDQ DS/DSHO arm with a cushioned bumper (won't fit with old style metal bumper).
- Manufactured from investment cast stainless steel for corrosion resistance and durability
- The 99032/99033 does not alter or decrease the strength of the DS/DSHO arm.
- Hand is determined in the field and reversible for LH and RH doors

Specifications

HANDING:	• Field Reversible
DOOR SIZES:	• SCS-1 for 3'0" X 8'0" doors • SCS-2 for 4'0" X 8'0" doors
FINISHES:	• 605 (US3) – Bright Brass (PVD), 613 (US10B) – Oil Rubbed Bronze (PVD), 630 (US32D) – Satin Stainless Steel, 693 – Black Note: PVD (Physical Vapor Deposition) coated finishes offer outstanding resistance to wear, durability and corrosion.

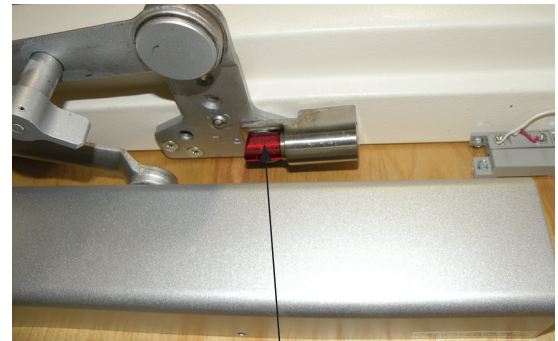

Note: Plunger Shown in Red To Enhance the Cushioning Feature.



Stop Shown Before Door is Fully Opened

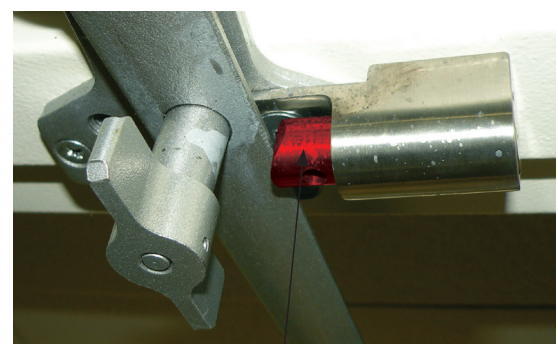

Stop Shown When Door is Fully Opened



Modern Styling. Space Saving. Hilton Hotels Approved.

PDQ's stainless steel sliding track systems, also referred to as Barn Door Hardware, offer the ideal solution when modern styling and space saving is demanded. Perfect for hospitality, offices, multi-family or mixed used facilities.



Standard Complies with Hilton Hotel Design Guide for Hampton Inns.

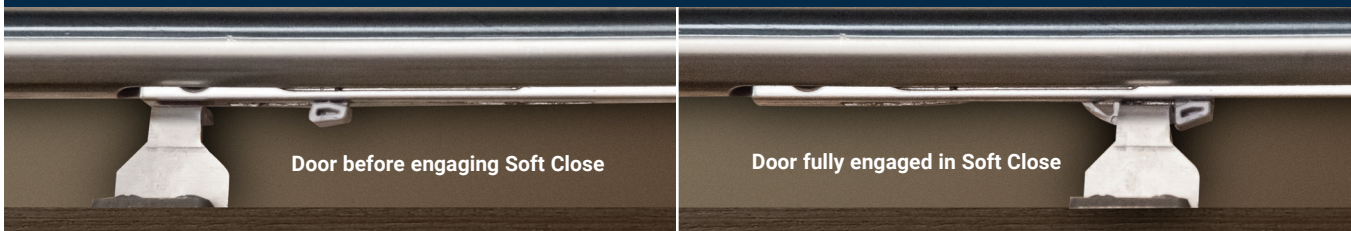

Soft Close Upgrade to PDQ's innovative WALLSAVER™ Soft Close, designed to gently bring the door to the stopped position. When the door is set in motion then captured by Soft Close, the dampened closing cycle minimizes the effect of impact loading to the wall brackets. The sleek design of the Soft Close mechanism is integrated into the track and replaces the need for rigid stops. Soft Close also maintains the door in the stopped position, preventing unwanted door creep.

Features:

- Door type: Wood, 1-3/4" thick.
- Max door weight: 220 lbs
- Grade 304 Stainless Steel components
- Nylon coated rollers
- Finish: 630 Satin Stainless Steel

Specifications

CONFIGURATIONS:	<ul style="list-style-type: none"> • Single • Bi-parting
INSTALLATION:	<ul style="list-style-type: none"> • Side Wall Mount (only)
PERFORMANCE:	<ul style="list-style-type: none"> • Meets ANSI/BHMA 156.14 Grade 1 Standard (100,000 cycles)
STANDARD KIT INCLUDES:	<ul style="list-style-type: none"> • 1 ea Track (specify length) • 2 ea Wall Brackets • 2 ea Track Stops • 2 ea Top Mount Hangers with Anti-jump pins • 1 ea Wood Guide • Installation fasteners



Full Mortise Hinges – Standard and Heavy Duty Spring Hinges



Plain Bearing
Standard Weight



2 Ball Bearing
Standard Weight



4 Ball Bearing
Heavy Weight



Spring Hinge
Standard Weight

Features

NON-REMOVABLE PIN (NRP):

- Included with all 2 and 4 ball bearing, std and heavy weight hinges.
- Groove in pin accepts set screw in center barrel.
- Set screw secured using a 3/32" hex (allen) wrench and is not accessible when door is closed.

TYPE:

- Full Mortise. Hinge leaves are mortised into the door and frame.

SWAGED:

- Standard.
- Provides 1/16" of clearance between both leaves when the hinge is in the closed position.



Power Transfer
Standard or
Heavy Weight

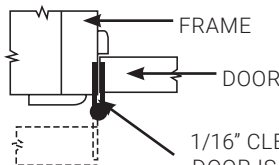

1/16" CLEARANCE WHEN DOOR IS IN THE CLOSED POSITION.

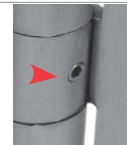

Non-Removable Pin (Red Arrow)



Specifications

MATERIALS:	<ul style="list-style-type: none"> • STEEL – Applications: Interior doors, non-corrosive environments. • STAINLESS STEEL – Applications: Exterior, doors, corrosive environments
PACKAGING:	<ul style="list-style-type: none"> • Qty Of Hinges Per Individual Carton: 3 ea For Plain, 2 Ball Bearing and 4 Ball Bearing Hinges 3 ea For Spring Hinges 1 ea for Electrified Hinges • Qty Of Hinges Per Master Carton: 48 ea For Plain, 2 Ball Bearing and 24 Ball Bearing Hinges
FASTENERS:	<ul style="list-style-type: none"> • All hinges packed with Machine Screws (12-24 x 1/2" FHMS) and Wood Screws (12 x 1-1/4" FHWS)
CERTIFICATIONS, LISTINGS, COMPLIANCES:	<ul style="list-style-type: none"> • Conforms with the requirements of NFPA 80-2010, Section 6.4.3.1. • Certified to ANSI/BHMA A156.1-2013: <ul style="list-style-type: none"> – Grade 3, Plain Bearing (PL) 350,000 cycles – Electrified hinges tested to over 100,000 cycles • UL listed: <ul style="list-style-type: none"> – SH Series Spring Hinges – EL Series Electrified Hinges
WARRANTY:	<ul style="list-style-type: none"> • Five (5) year limited warranty

Electrified Hinges



Electrified Hinges

FEATURES	QTY OF HINGES PER CARTON	CODE	DESCRIPTION
	1ea	EL 4	Concealed electric through-wire (2 wires @ 20ga, 2 wires @ 26ga)
		EL 8	Concealed electric through-wire (8 wires, 28ga)

Key Switches



- Maintained or Momentary
- Can be Keyed Into Master Key System
- Stainless Steel Faceplate
- Indicators Available

Push Buttons



- Maintained or Momentary
- Stainless Steel Faceplate



9910 Series Surface Mounted Electric Strike

ELECTRIC STRIKES

Features

- Completely surface-mounted
- Accommodates 1/2" to 3/4" (13mm–19mm) latch projection
- Mounting spacer included to provide enhanced latch engagement
- Stainless steel ensures superior strength and creates a sleek aesthetic design
- Horizontal adjustment ensures proper latch positioning to compensate for door misalignment – up to 1/4" (6.4mm)
- Conventional keeper design
- Plug-in wire connectors
- Lockdown holes for secure mount
- HEX socket head cap screws for added support
- Installation tool included
- Non-handed
- 500mA Field-Selectable 12/24VDC & 12-24VAC (Max at 12VDC)
- 1,500lbf Static
- 70 ft-lb Dynamic
- 250,000 Cycles
- Fail-Secure
- 3-Hour Fire Rated
- 5 Year Limited Warranty

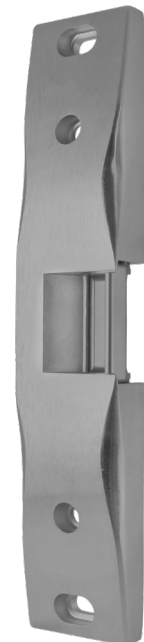

9910

PS SERIES

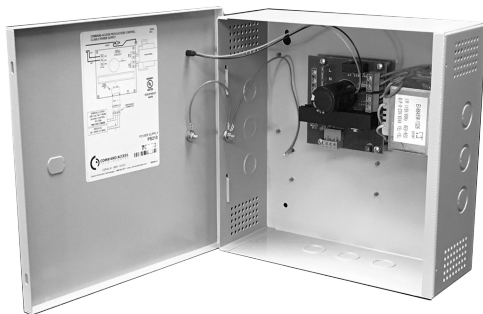

PS220

Features

- Filtered/Regulated 24 Volts DC
- Overload, Over Voltage and Short Circuit Protection
- Accepts 120VAC
- Controls Fail Safe or Fail Secure Locking Devices
- interface Relay Isolates Locking Device Current from Control Switch
- Auxiliary 24VDC Constant Voltage Output for Powering Stand Alone Devices, Such as, Keypads, Motion Detectors and Status Indicators (Model PS220B only)
- Surge Suppression on Fail Safe and Fail Secure Outputs
- UL Listed and Tested to 294 Standard for Access Control System Units
- 3 year warranty



PART	DESCRIPTION
PS220	2A @ 24VDC Power Supply w/ Fire Alarm Link and 0.5A auxiliary power (continuous)
PS220B	2A @ 24VDC Power Supply w/ Fire Alarm Link, 0.5A auxiliary power (continuous) and Battery Backup (batteries sold separately)
PS440B	4A @ 24VDC Power Supply w/ Fire Alarm Link, and Battery Backup (batteries sold separately)
PS480B	8A @ 24VDC Power Supply w/ Fire Alarm Link, and Battery Backup. Batteries not included (accommodates 2 ea. 7AH batteries)



Privacy Latch Guards



Flush and Surface Bolts

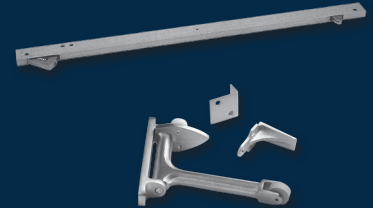

Coordinators



Push Plates



Pulls and Pull Plates

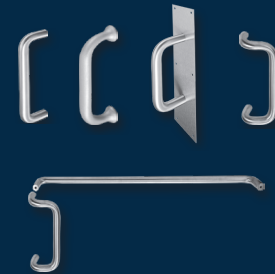

Push and Push-Pull Bars

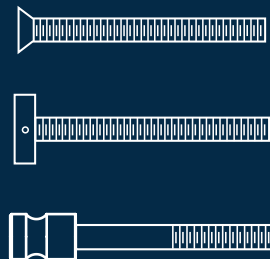

Fasteners

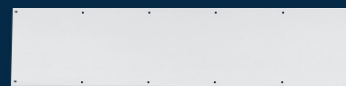

Door Protection Plates



**Wall Stops
and Holders**



**Floor Stops
and Holders**



**Kick Down
Door Holders**



Hinge Stops



Roller Stops

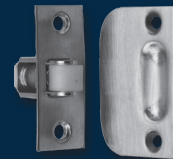

**Roller Latches,
Catches and
Protectors**



**Door Viewers,
Silencers**

SKILCRAFT®/PDQ Hardware Assembled by the Blind

PDQ is proud to be partnered with CABVI under the US AbilityOne program

This partnership facilitates the employment of people who are blind or have significant other disabilities in the production of ANSI/BHMA Grade 1 door hardware. Under the SKILCRAFT® brand, blind and visually impaired US citizens assemble door hardware using PDQ components for use by all federal government agencies.

Federal Law Requires the Use of SKILCRAFT®/PDQ Hardware Products on Federally Funded Projects

- Federal Law (Javits -Wagner-O'Day Act 41 U.S.C. & et seq) requires all Federal Agencies to purchase Supplies and Services from nonprofits who employ people who are blind or have significant other disabilities.
- Compliance with FAR 52 208-9 – Contractor Use of Mandatory Sources of Supply and Services means SKILCRAFT®/PDQ hardware products designated as mandatory use items are specified for new construction/major renovations and maintenance of all federally funded buildings.
- Only AbilityOne hardware products which carry the SKILCRAFT®/PDQ cobrand can be used on federally funded projects and have no equal for federal procurement and no substitutions allowed.



SKILCRAFT® / PDQ Door Hardware

ANSI/BHMA
Grade 1



Mortise Locks



Cylindrical Locks



Door Closers



Exit Devices

For more information, contact SKILCRAFT® / PDQ® or visit www.pdqlocks.com/federal-government

PDQ Manufacturing Limited Warranty

Grade 1 Lock Product	
MR Series Mortise Locks	Lifetime Warranty
XGT Series	Lifetime Warranty
GT Series	25-Year Warranty
SX Series	5-Year Warranty
Grade 2 Lock Product	
GP Series	8-Year Warranty
SD Series	5-Year Warranty
SF Series	3-Year Warranty
SV Series	1-Year Warranty
CL Series	2-Year Warranty
TJ Series Decorative Tubular	
TJ Series	5-Year Warranty
Deadbolts	
K Series	1-Year Warranty
Closers	
3100 Series	25-Year Warranty
5100 Series	25-Year Warranty
5300 Series	25-Year Warranty
5500 Series	25-Year Warranty
7100 Series	25-Year Warranty
Exit Devices	
4200 Series	5-Year Warranty
6300 Series	10-Year Warranty
6400 Series	10-Year Warranty
Mullions	
Mullions	10-Year Warranty
Hinges, Flat Goods and Sliding Barn Door Hardware	
Commercial Hinges	5-Year Warranty
Flat Goods	5-Year Warranty
Sliding Barn Door Hardware	5-Year Warranty
Electrified Products	
Mechanical Components	Series Warranty
Electric Components	2-Year Warranty

PDQ Manufacturing ("PDQ") warrants that, during the applicable warranty period set forth in the chart to the left, its products will be free from defects in workmanship and materials under normal use and service conditions. If a product or a component part thereof is found to be defective, PDQ will, at its sole discretion, either repair or replace such defective item. If PDQ no longer manufactures the particular product or component, PDQ reserves the right to substitute an item which PDQ deems to be comparable or superior in its place.

A warranty claim must be initiated by calling PDQ's toll-free number at 800.441.9692. A brief description of the defect will be required, and further instructions for returning the product will be given. The provision of return instructions is not a guarantee that the product will be covered under this warranty.

This warranty does not cover:

- Defects or damage arising from improper installation; lack of or improper maintenance; improper storage, shipping or handling; corrosion; erosion; ordinary wear and tear; misuse or abuse; or accident.

- Products which have been modified in any way, regardless of whether such modification caused or contributed to the alleged defect.

- The protective coatings and finishes applied to the surface of the product (wear or tarnishing of such finishes is considered "ordinary wear and tear").

- Labor costs, including the costs of removing and reinstalling the product.

- Shipping charges incurred in returning the product to PDQ.

- This Limited Warranty does not apply to ANSI A156.2 Grade 2 Key-In-Lever product installed on Educational Facilities.

All products returned to PDQ will be inspected to verify that (1) the alleged defect does exist, and (2) none of the exclusionary conditions listed above (abuse, corrosion, modification, etc.) is present. Products deemed not to be "in warranty" will be returned to the customer at the customer's expense.

This warranty is exclusive and in lieu of all other warranties, express and implied, including the implied warranties of merchantability and fitness for a particular purpose.

PDQ's maximum liability hereunder is limited to the original purchase price of the product.

PDQ shall not be liable for any incidental, consequential, indirect, special, exemplary or punitive damages, whether based on contract, warranty, tort (including strict liability and negligence), patent infringement or any other theory of liability, even if advised of the possibility of such damage. No agent, sales representative or dealer has the authority to increase or alter PDQ's obligations under this warranty.

LEVER	MORTISE		CYLINDRICAL			TUBULAR	BALL KNOB	EXIT DEVICE TRIMS
	F-TRIM	J-TRIM	GRADE 1	GRADE 2	INTERCONNECTED			
 Philadelphia- PHL	MR F-Trim	MR J-Trim	XGT, GT	GP, SD, SF	CL	TJ		6N, 6NM, 6W, 6WM, 6S
 Boston- BSN	MR F-Trim	MR J-Trim	XGT, GT	GP, SD, SF	CL	TJ		6N, 6NM, 6W, 6WM, 6S
 Miami- MIA	MR F-Trim	MR J-Trim	XGT, GT	GP, SD, SF	CL	TJ		6N, 6NM, 6W, 6WM, 6S
 Chicago- CHI		MR J-Trim				TJ		6N, 6NM, 6W, 6WM
 Dallas- DAL		MR J-Trim				TJ		
 Houston- HOU		MR J-Trim				TJ		
 Memphis- MEM*		MR J-Trim		SD, SF	CL	TJ		
 Orlando- ORL		MR J-Trim		SD, SF	CL	TJ		6N, 6NM, 6W, 6WM
 Los Angeles - LAX		MR J-Trim				TJ		6N, 6NM, 6W, 6WM
 Ball-Knob		MR J-Trim				TJ	SX, SV	

* specify handing

Architectural



605 (US3)
Bright Brass



606 (US4)
Satin Brass



612 (US10)
Satin Bronze



613E
Oil Rubbed Bronze



619 (US15)
Satin Nickel



622 (US19)
Flat Black



625 (US26)
Bright Chromium



626 (US26D)
Satin Chromium



629 (US32)
Bright Stainless
Steel



630 (US32D)
Satin Stainless
Steel

Painted



689 (US28)
Aluminum



693 Black

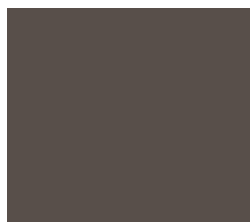

695
Dark Duranodic
Bronze



696 (US4)
Satin Brass (Gold)

Finishes shown are representative only. PDQ cannot guarantee that product shipped will match finishes shown.
Not all products are available in all finishes listed.



Architectural Finishes by Product Series

FINISH	MORTISE		CYLINDRICAL		
	F-TRIM	J-TRIM	GRADE 1	GRADE 2	INTERCONNECTED
605 (US3) Bright Brass		MR J-Series	XGT, GT	GP, SD, SF	CL
606 (US4) Bright Brass		MR J-Series	XGT, GT	GP	
612 (US10) Stain Bronze		MR J-Series	XGT, GT	GP	
613E Oil Rubbed Bronze		MR J-Series	XGT, GT	GP, SD, SF	CL
619 (US15) Stain Nickel			XGT, GT	SF	
622 (US19) Flat Black		MR J-Series	XGT, GT	GP, SD, SF	CL
625 (US26) Bright Chromium			XGT, GT	GP, SF	
626 (US26D) Satin Chromium	MR F-Series		XGT, GT	GP, SD, SF	CL
629 (US32) Bright Stainless Steel		MR J-Series			
630 (US32D) Stain Stainless Steel		MR J-Series			



Architectural Finishes by Product Series

FINISH		BALL KNOB	TUBULAR LOCK	DEADBOLTS	EXIT DEVICES*	DEVICE TRIMS	CLOSERS	HINGES**
605 (US3) Bright Brass		SV	TJ	MJ, KM KT, KV	6300R, 6400R, 6300V, 6400V, 6300C, 6400C, 6300M, 6300D, 4200R, 4200V	6N, 6NM, 6W, 6WM, 6S, 6C, 6CM, 4EN, 4S, 4GW	7100, 5100 5300, 5500	35ST BB 35ST HB 35ST SH
606 (US4) Bright Brass			TJ	MJ, KM KT, KV	6300R, 6400R, 6300V, 6400V, 6300C, 6400C, 6300M, 6300D	6N, 6NM, 6W, 6WM, 6S, 6C, 6CM		
612 (US10) Stain Bronze			TJ	MJ, KT				
613E Oil Rubbed Bronze		SV	TJ	MJ, KM KT, KV	6300R, 6400R, 6300V, 6400V, 6300C, 6400C, 6300M, 6300D	6N, 6NM, 6W, 6WM, 6T, 6P, 6G, 6GM, 6S, 6C, 6CM, 4EW, 4S, 4K		35ST PL 35ST BB 35ST HB 35ST SH
619 (US15) Stain Nickel			TJ			6C, 6CM		35ST PL 35ST BB 32ST HB 35ST HB 35ST SH
622 (US19) Flat Black			TJ	KM, KV	6300R, 6400R, 6300V, 6400V, 6300C, 6400C, 6300M, 6300D	6N, 6NM, 6W, 6WM, 6T, 6P, 6G, 6GM, 6S, 6C, 6CM		35ST PL 35ST BB 35ST HB 35ST SH 35SS BB
625 (US26) Bright Chromium				KT	6300R, 6400R, 6300V, 6400V, 6300C, 6400C, 6300M, 6300D	6N, 6NM, 6W, 6WM, 6C, 6CM	7100, 5100 5300, 5500	
626 (US26D) Satin Chromium				KM, KT, KV	6300R, 6400R, 6300V, 6400V, 6300C, 6400C, 6300M, 6300D, 4200R, 4200V	6N, 6NM, 6W, 6WM, 6S, 6C, 6CM, 4EW, 4EN, 4S, 4GW		35ST PL 35ST BB 35ST HB 35ST SH 35SS BB
629 (US32) Bright Stainless Steel			TJ	MJ				
630 (US32D) Stain Stainless Steel		SX, SV	TJ	MJ, KM, KV	6300R, 6400R, 6300V, 6400V, 6300C, 6400C, 6300M, 6300D, 4200R, 4200V	6T, 6P, 6G, 6GM, 6S, 4K, 4GW		35SS BB 35SS HB 35SS SH

*Check specific exit device models for finish availability. 6300 and 6400 exit devices also available in 630F.

**Hinges also available in 600.





Painted Finishes by Product Series

FINISH		CLOSERS	EXIT DEVICES	
			EXIT DEVICES	TRIMS
689 (US28) Aluminum		7100, 5100, 5300, 5500, 3100	4200R, 4200V	4EN, 4P, 4GW
693 Black		7100, 5100, 5300, 5500, 3100		
695 Dark Duranodic Bronze		7100, 5100, 5300, 5500, 3100	4200R, 4200V	4EN, 4P, 4GW
696 (US4) Stain Brass (Gold)		7100, 5100, 5300, 5500, 3100	4200R, 4200V	

FINISH	FLAT GOODS	GENERAL HARDWARE
Assorted	See Price Book	



SECURING
CONFIDENCE
OPENING
POSSIBILITIES

Phone: 717.656.4281

Tech Support: 833.273.7832

Email: help@pdqlocks.com

Headquarters: 2230 Embassy Drive, Lancaster, PA 17603
P.O. Box 6426, Lancaster, PA 17607

Regional Distribution Centers: Lancaster, PA | Norcross, GA |
Auburn, WA